

# KOMATSU

## PC360LC-11 PC360LCi-11

**intelligent** / 2.0  
MACHINE CONTROL

EPA Tier 4 Final Engine  
Australia & New Zealand Specifications



Photos may include optional equipment.

Hydraulic  
excavator

**Horsepower  
Gross & NET**  
192 kW / 257 HP@1950 rpm

**Operating  
weight range**  
35,950 – 37,440 kg

**Bucket capacity range**  
0.53 – 1.80 m<sup>3</sup>

# Greater performance and **Faster cycle times**

NET Horsepower

**192 kW / 257 HP@1950 rpm**

Operating weight

**35,950 – 37,440 kg**

Bucket capacity

**0.53 – 1.80 m<sup>3</sup>**



Photos may include optional equipment.

## **Komatsu's Closed-centre Load Sensing System (CLSS)**

provides quick response and smooth operation to maximise productivity.

\*All Models

## **New engine and hydraulic control technology**

improves operational efficiency and lowers fuel consumption by up to 11%.

## **A powerful Komatsu SAA6D114E-6 engine**

provides a net output of 192 kW 257 HP. This engine is EPA Tier 4 Final emissions certified.

## **Komatsu Variable Geometry Turbocharger (KVGT)**

uses a hydraulic actuator to provide optimum air flow under all speed and load conditions.

## **Komatsu Diesel Particulate Filter (KDPF) and Selective Catalytic Reduction (SCR) system**

reduce particulate matter and NOx while providing automatic regeneration that does not interfere with daily operation.

## **Large displacement high efficiency pumps**

provide high flow output at lower engine speed, improving efficiency.

**Two boom mode settings** provide power mode for maximum digging force or smooth mode for fine grading operations.

**KOMTRAX®** equipped machines can send location, SMR and operation maps to a secure website or smart phone utilising wireless technology. Machines also relay error codes, cautions, maintenance items, fuel & Diesel Exhaust Fluid (DEF) levels, and much more.

## **Komatsu designed and manufactured components**

**Handrails (standard)** located on the machine upper structure provide a convenient work area in front of the engine.

**Lockable single pole battery isolation switch** allows a technician to disconnect the power supply before servicing the machine.

**Heavy duty boom** design with large one piece castings provide increased strength and durability.

**Komatsu Auto Idle Shutdown** helps reduce nonproductive engine idle time and reduces operating costs.

**Operator Identification System** records KOMTRAX® machine operation and application data for up to 100 individual ID codes.

## **Large LCD colour machine monitor:**

- 7" high resolution display
- Enhanced hydraulic attachment control with one way/two way flow and programmable work tool names and settings
- Key machine settings and controls easily accessible through the monitor.

## **Rearview monitoring system (standard)**

with integrated camera display in the default monitor screen.

**KomVision (standard)** are designed to match engine speed, pump delivery and system pressure to the application.

## **Enhanced working environment:**

- High back, heated air suspension seat with new adjustable arm rests
- Integrated ROPS cab design
  - Conforms to [ISO 12117-2] for excavators, also satisfies Level 1 operator Protective Guard [OPG] and Top guard [ISO 10262]
- AUX jack and [2] 12V power outlets.



# Komatsu new engine technologies

## Komatsu's new emission regulations-compliant engine

New regulations effective in 2018 require the reduction of NOx emissions to one tenth or below from the preceding regulations. In addition to refining the Tier 4 Interim technologies, Komatsu has developed a new Selective Catalytic Reduction (SCR) device in-house.

## Technologies applied to new engine

### Heavy-duty aftertreatment system

This new system combines a Komatsu Diesel Particulate Filter (KDPF) and Selective Catalytic Reduction (SCR). The SCR NOx reduction system injects the correct amount of Diesel Exhaust Fluid (DEF) at the proper rate, thereby decomposing NOx into non-toxic water vapour (H2O) and nitrogen gas (N2).

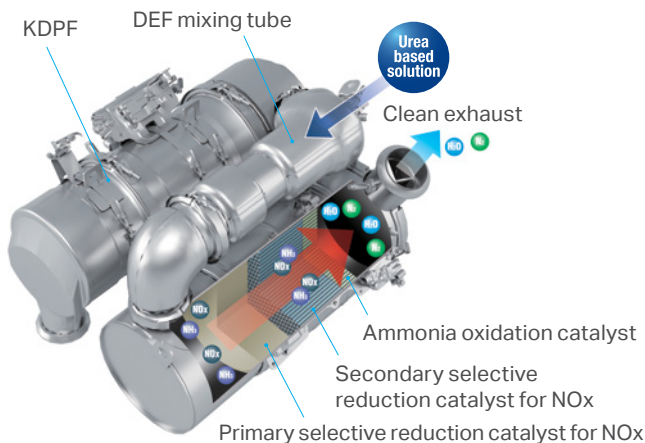
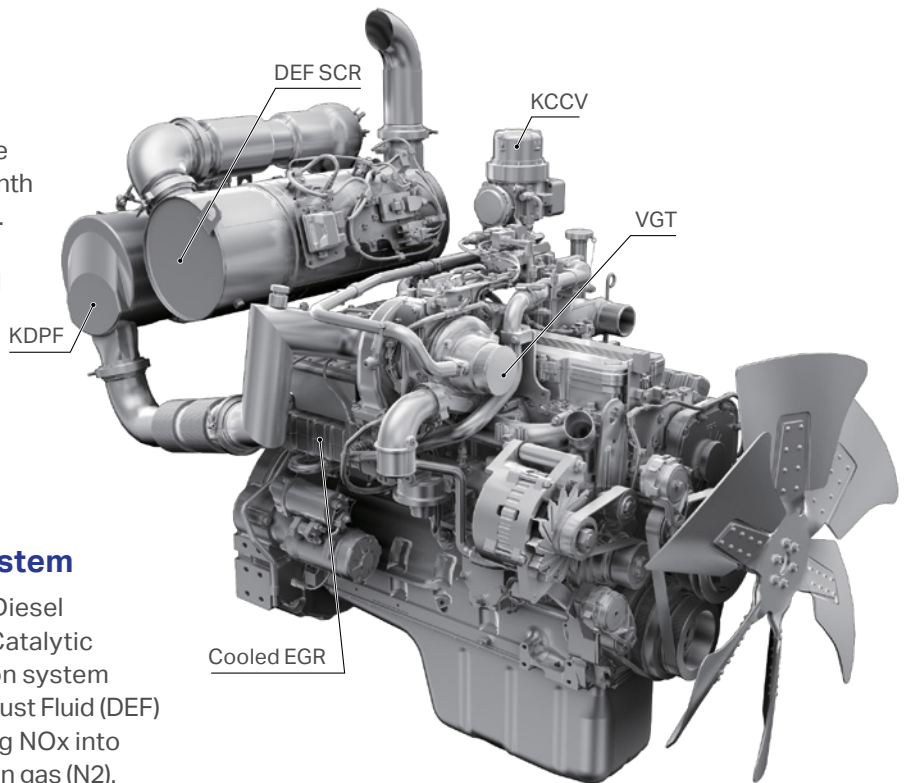

### Heavy-duty cooled Exhaust Gas Recirculation (EGR) system

The system recirculates a portion of exhaust gas into the air intake and lowers combustion temperatures, thereby reducing NOx emissions. EGR gas flow has been decreased for Tier 4 Final with the addition of SCR technology.

The system achieves a dynamic reduction of NOx, while helping reduce fuel consumption below Tier 4 Interim levels.

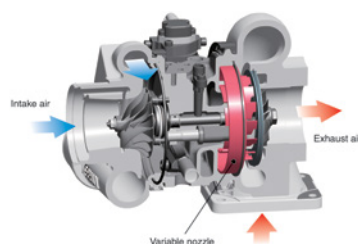

### Advanced electronic control system

The electronic control system performs high-speed processing of all signals from sensors installed in the vehicle providing total control of equipment in all conditions of use. Engine condition information is displayed via an on-board network to the monitor inside the cab, providing necessary information to the operator. Additionally, managing the information via KOMTRAX helps customers keep up with required maintenance.

### Komatsu Variable Geometry Turbocharger (KVG) system

The VGT system features proven Komatsu design hydraulic technology for variable control of air-flow and supplies optimal air according to load conditions. The upgraded version provides better exhaust temperature management.

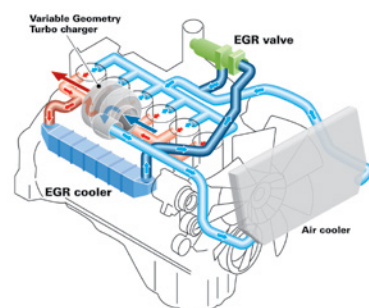

### Komatsu auto idle shutdown

Komatsu auto idle shutdown automatically shuts the engine down after idling for a set period of time to reduce unnecessary fuel consumption and exhaust emissions.



### Heavy-Duty High-Pressure Common Rail (HPCR) fuel injection system

The system is designed to achieve an optimal injection of high-pressure fuel by means of Computerised control, providing close to complete combustion to reduce PM emissions. While this technology is already used in current engines, the new system uses high pressure injection, thereby reducing both PM emissions and fuel consumption over the entire range of engine operating conditions.

The Tier 4 Final engine has advanced fuel injection timing for reduced fuel consumption and lower soot levels.

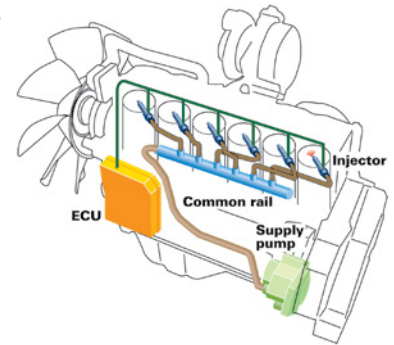

## Performance features

### Reduced fuel consumption

The PC360LC-11's new tier 4 final engine along with enhancements in the hydraulic system considerably decreases fuel consumption.

#### Fuel consumption

## Reduced by 11%

(vs PC350LC-8M0 Based on typical work pattern collected via Komtrax)

This fuel consumption data is the result compared actual measured value using the prototype machine.

### Increased work efficiency

### Large digging force

With the one-touch Power Max. function, digging force is increased for 8.5 seconds of operation.

#### Maximum arm crowd force (ISO)

160 kN(16.3t) ➔ **171 kN(17.4t) 7% UP**  
(With Power Max.)

#### Maximum bucket digging force (ISO)

213 kN(21.7t) ➔ **228 kN(23.2t) 7% UP**  
(With Power Max.)

Measured with Power Max. function, 3200 mm arm and ISO rating.

### Faster arm cycle speeds

Two return hoses improve arm cylinder hydraulic flow for faster arm out performance.

### Two-mode settings for boom

- Smooth boom mode reduces boom down force for working on hard surfaces or for hydraulic hammer operation.
- Power boom mode maximises digging force for more effective excavating.

### Lifting mode

When the Lifting mode is selected, lifting capacity is increased 7% by raising hydraulic pressure.



## Drawbar pull

The Komatsu designed final drives and undercarriage provide high drawbar pull for good maneuverability and performance when working on adverse grades or soft ground.



## Efficient hydraulic system

The PC360LC-11 uses a Closed-centre Load Sensing System (CLSS) that improves fuel efficiency and provides quick response to the operator's demands. The PC360LC-11 also incorporates new technology to enhance the engine and hydraulic pump control. This total control system matches the engine and hydraulics at the most efficient point under any load condition. There have also been improvements in the main valve and hydraulic circuit to reduce hydraulic loss, resulting in higher efficiency and lower fuel consumption.

## Large displacement high efficiency pump

Large displacement hydraulic implement pumps provide high flow output at lower engine RPM as well as operation at the most efficient engine speed.



## Working mode selection

The PC360LC/PC360LCi-11 excavator is equipped with six working modes (P, E, L, B, ATT/P and ATT/E). Power Mode provides improved hydraulic power and faster cycle times for improved performance in demanding applications. Each mode is designed to match engine speed, pump flow, and system pressure to the application. The PC360LC/PC360LCi-11 features an attachment mode (ATT/E) that allows operators to run attachments while in Economy mode.

Working mode	Application	Advantage
<b>P</b>	Power Mode	Maximum production, power and multifunction
<b>E</b>	Economy Mode	Good cycle times with reduced fuel consumption
<b>L</b>	Lifting Mode / Fine Control	Increased lifting power and fine control
<b>B</b>	Breaker Mode	One way flow for hydraulic breaker operation
<b>ATT/P</b>	Attachment Power Mode	Two way flow with maximum power
<b>ATT/E</b>	Attachment Economy Mode	Two way flow with most efficient fuel economy

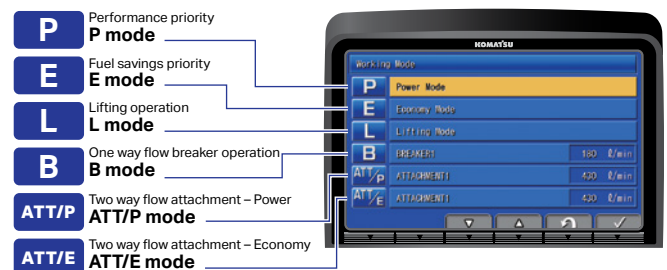

## High rigidity work equipment

Booms and arms are constructed with thick plates of high tensile strength steel. In addition, these structures are designed with large cross sectional areas and large one piece castings in the boom foot, the boom tip, and the arm tip.

The result is work equipment that exhibits long term durability and high resistance to bending and torsional stress. A standard HD boom design provides increased strength and reliability.

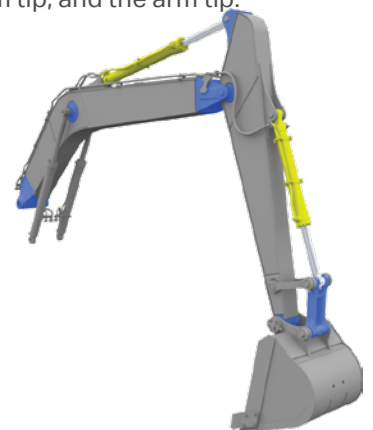

# Working environment







## Comfortable working space

### Wide spacious cab

Wide spacious cab includes seat with reclining backrest. The seat height and longitudinal inclination are easily adjusted using a pull-up lever. You can set the appropriate operational posture of armrest together with the console. Reclining the seat further enables you to place it into the fully flat state with the headrest attached.

### Arm rest with simple height adjustment function

The addition of a knob and a plunger to the armrest permits the height of the armrest to be easily adjusted without the use of tools.



Low vibration with cab damper mounting  
Automatic climate control.

### Pressurised cab

### IMC 2.0 UHF and network antenna

UHF and Network Antenna - providing corrections, service and Remote support capability.

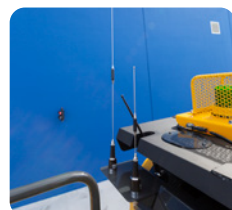

## Standard equipment

Sliding window glass (left side)



AM/FM Bluetooth radio



Remote intermittent wiper with windshield washer

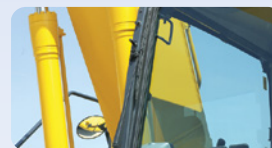

Emergency stop and level indicator



ISO Level 2 OPG



Magazine box and cup holder



Defroster (conforms to the ISO standard)



One-touch storable front window lower glass



# Working environment

## Large high resolution LCD monitor



### New monitor panel interface design

An updated large high resolution LCD colour monitor enables accurate and smooth work. The interface has been redesigned to display key machine information in a new user friendly interface. A rear view camera and a DEF level gauge display have been added to the default main screen. The interface has a function that enables the main screen mode to be switched, thus enabling the optimum screen information for the particular work situation to be displayed.

#### Indicators

- |                                    |                             |
|------------------------------------|-----------------------------|
| 1 Auto-decelerator                 | 8 Fuel gauge                |
| 2 Working mode                     | 9 DEF level gauge           |
| 3 Travel speed                     | 10 Service metre, clock     |
| 4 Ecology gauge                    | 11 Fuel consumption gauge   |
| 5 Camera display                   | 12 Guidance icon            |
| 6 Engine coolant temperature gauge | 13 Function switches        |
| 7 Hydraulic oil temperature gauge  | 14 Camera direction display |
|                                    | 15 DEF level caution lamp   |

#### Basic operation switches

- |                         |                         |
|-------------------------|-------------------------|
| 1 Auto-decelerator      | 5 Wiper                 |
| 2 Working mode selector | 6 Window washer         |
| 3 Travel speed selector | 7 Auto climate controls |
| 4 Buzzer cancel         |                         |

### KomVision

(Standard on all models manufactured after August 2021)

Images from 4 camera's are combined to display a "birds eye" view of the area around the machine for improved operator awareness. A second display with selectable individual camera views of the left, rear, and right sides is easily changed using the F4 button. A red line continuously shows where the counterweight will be during swinging and a camera icon indicates which camera is being displayed on individual camera display screen.



### Visual user menu

Pressing the F6 key on the main screen displays the user menu screen. The menus are grouped for each function, and use easy-to-understand icons which enable the machine to be operated easily.



- |                                       |                   |
|---------------------------------------|-------------------|
| 1 Energy saving guidance              | 4 SCR information |
| 2 Machine settings                    | 5 Maintenance     |
| 3 Aftertreatment devices regeneration | 6 Monitor setting |
|                                       | 7 Message check   |



## Support efficiency improvement

### Ecology gauge and fuel consumption gauge

The monitor screen is provided with an ecology gauge and also a fuel consumption gauge which is displayed continuously.

In addition, the operator can set any desired target value of fuel consumption (within the range of the green display), enabling the machine to be operated with better fuel economy.

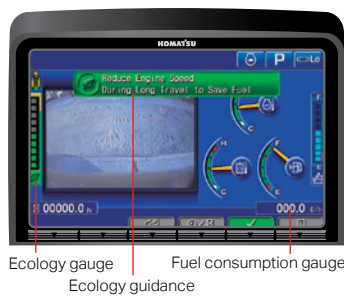

Ecology gauge      Fuel consumption gauge  
Ecology guidance

### Operator Identification Function

An identification ID can be set up for individual operator, application or jobs, and used to manage operation information of individual machines using KOMTRAX data. Data sent from KOMTRAX can be used to analyse operation status by operator as well as by machine.



### Ecology guidance

While the machine is operating, ecology guidance pops up on the monitor screen to notify the operator of the status of the machine in real time.

### Operation record, fuel consumption history, and ecology guidance record

The ecology guidance menu enables the operator to check the operation record, fuel consumption history and ecology guidance record from the ecology guidance menu, using a single touch, thus enabling the total fuel consumption to be reduced.



Operation record

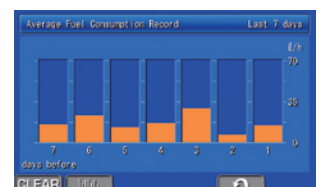

Fuel consumption history

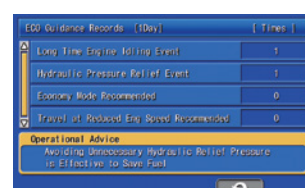

Ecology guidance record

## intelligent MACHINE CONTROL 2.0

### Make every pass count

Improve your efficiency – intelligent Machine Control means fast excavation to finish grade.

Semi-automatic operation – new features such as bucket angle hold control provide high levels of accuracy and comfort.



### Innovative

- intelligent Machine Control excavator features semi-automatic operation of work equipment for highly accurate work.
- Compact 10.4" iMC monitor with increased memory capacity, processing speed, and pinch to zoom capability.

**NEW**

### Integrated

- Complete factory-installed and integrated intelligent Machine Control system comes standard with stroke sensing hydraulic cylinders.
- Multiple Global Navigation Satellite System (multi-GNSS) components and an Inertial Measurement Unit (IMU) sensor. All components are validated to Komatsu's rigid quality and durability standards.
- Multi-band UHF/915SS radio improves job site flexibility.
- 3G/4G LTE connectivity for fast reliable job site connectivity.
- DUHF II Radio Standard fitment & 915SS Optional equipment – offers improved jobsite flexibility.

**NEW**

**NEW**

**NEW**

**NEW**

### Intelligent

- Intelligent Machine Control excavator allows the operator to focus on moving material efficiently while semi-automatically tracing the target surface and limiting over-excavation.
- Facing angle compass, light bar and sound guidance aid in ease of operation and bucket positioning.
- Bucket Angle Hold and optional Auto-Tilt Attachment Control increase ease of operation and improve productivity and efficiency.

**NEW**



# intelligent machine control



## intelligent machine control

intelligent Machine Control is based on Komatsu's unique sensor package, including stroke sensing hydraulic cylinders, an IMU sensor, and GNSS antennas. It utilises 3D design data loaded in the control box to accurately check its position against the target. If the bucket hits the target surface, it is semi-automatically limited to minimise over-excitation. If the operator turns off Auto mode, the machine can be operated with highly accurate, responsive machine guidance, with the machine only providing indication guidance.

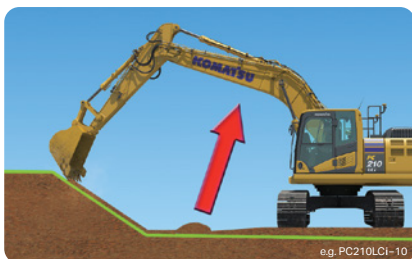

### • Auto grade assist

With the auto grade assist function, the operator moves the arm, the boom adjusts the bucket height automatically, tracing the target surface and minimising digging too deep. This allows the operator to perform rough digging without worrying about the design surface, and to perform fine digging by operating the arm lever only. The working range is extended by holding the lever to move the boom downward.

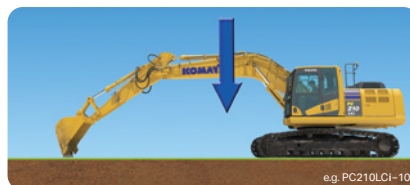

### • Auto stop control

During boom or bucket operation, the work equipment automatically stops when the bucket edge reaches the design surface, thus minimising damage to the design surface.



### • Minimum distance control

The intelligent Machine Control excavator controls the bucket by automatically selecting the point on the bucket closest to the target surface. Should the machine not be facing a sloped surface at a right angle, it will still follow the target surface and minimise digging below it.

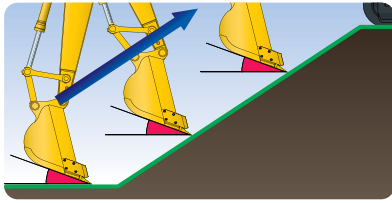

**NEW**

• **Bucket angle hold control**

Operator sets desired bucket angle and the system automatically maintains bucket angle throughout the grading pass. Angle hold control increases ease of operation and improves final grading accuracy.

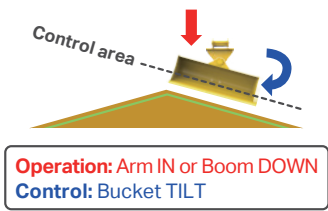

**NEW**

**Operation:** Arm IN or Boom DOWN  
**Control:** Bucket TILT

• **Auto-tilt Attachment Control**

Automatically tilts bucket to design surface and returns it to horizontal to unload. Using auto tilt control with the existing minimum distance control and auto grade assist makes complex grading quicker and easier.

**Improved construction efficiency**

Staking, survey and final inspection (which is usually done manually), can be reduced with the intelligent Machine Control excavator by setting 3D design data on the control box. Also, use of the facing angle compass can minimise leveling work for the surface on which the machine sits. Even if the machine is inclined while working, the facing angle compass allows the operator to ensure that the machine is facing perpendicular to the target surface. The intelligent Machine Control technology allows the operator to improve work efficiency (i.e. shorter construction time) while minimising over-excavating the target surface from rough digging to finish grading.

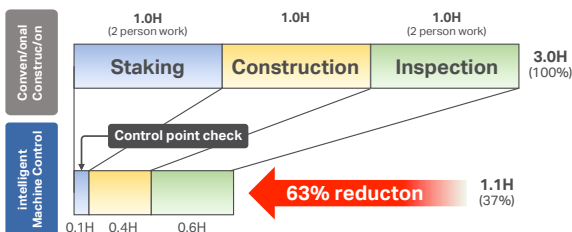

\* When used by a qualified iMC operator, the Komatsu intelligent Machine Control system increases construction efficiency.  
\* The above data does not include design time or working data creation time. The above data is based on in-house construction tests, performed by Komatsu, whose conditions may differ from actual construction.

**Improved work accuracy**

The bucket edge/tip position is instantly displayed on the control box, eliminating the wait time for display on the monitor during construction. The large and easy-to-view control box displays information clearly, aiding in highly accurate work. With manual operation and conventional machine guidance, finish grade quality and excavating accurately depends heavily on the skill of the operator. With the intelligent Machine Control excavator, the bucket is automatically limited to follow the target grade without over-excavating.

**Relationship between finished surface and allowable value**

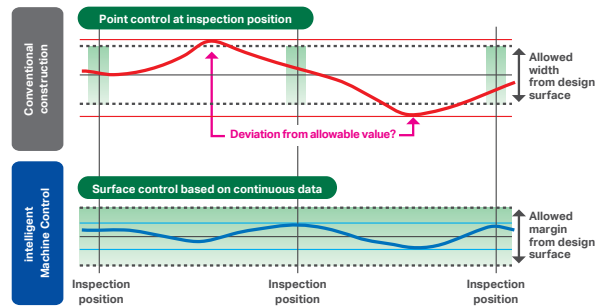

**As-built surface mapping**

Operator can display and check the as-built status and find where to cut and fill.

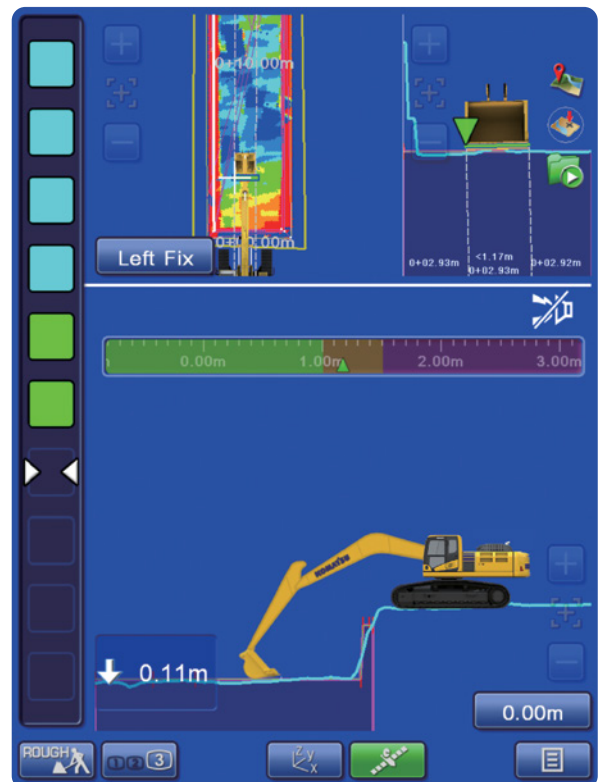

# intelligent machine control

## Control box

The monitor of the Komatsu intelligent Machine Control (control box) uses a compact 10.4" screen for visibility and ease of use. The simple screen layout displays the necessary information in an easily understood fashion. Touch screen icon interface instead of multi-step menu simplifies operation.

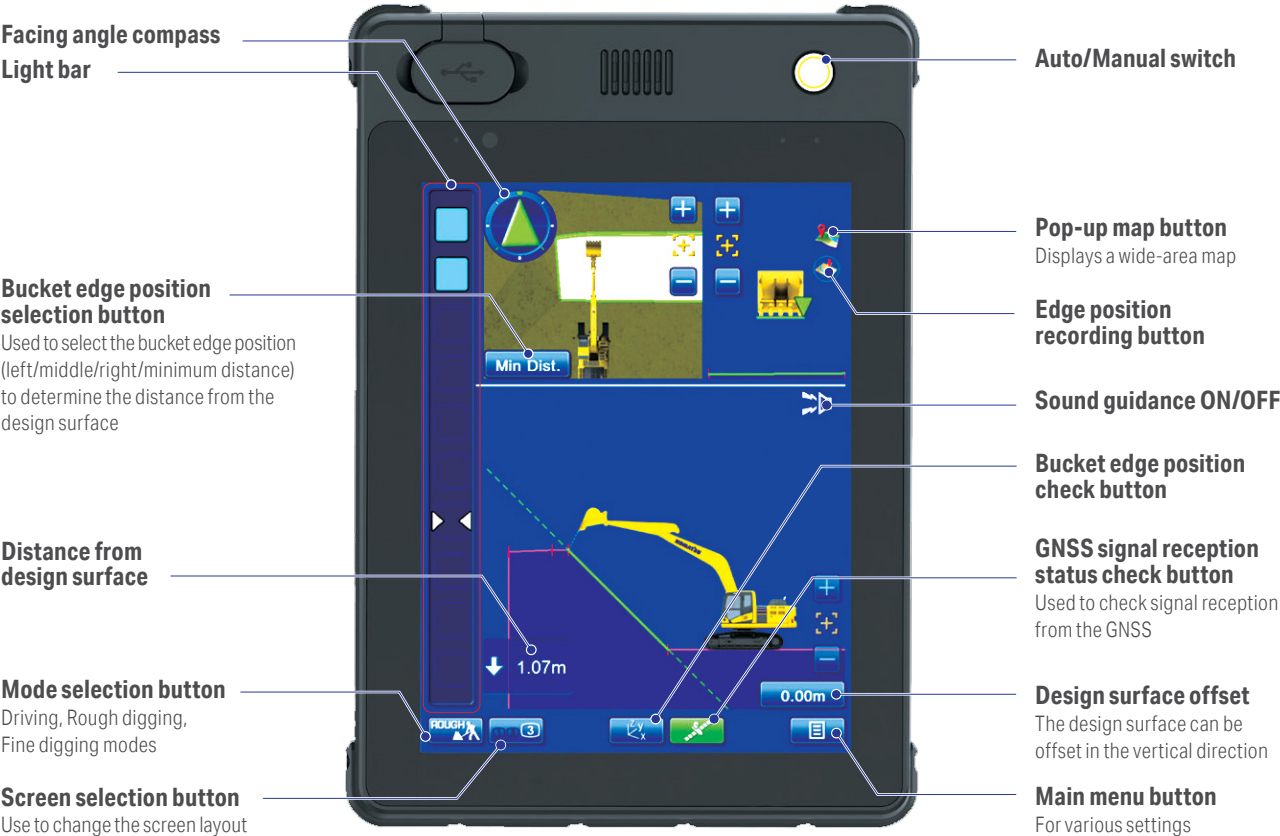

**Preset Elevation Offset Quick Button** +0.500'

Pre-determined offsets can be stored in the monitor to allow an operator to easily switch between preset grades. NEW

Offset preset	0.000'	Apply
	0.500'	Apply
	1.500'	Apply

Button switch mode Offset preset

**Quick Bucket Swap Button** NEW

Allows users to quickly swap between various buckets without having to enter main menu. This lessens the time a user takes to change out a bucket on the monitor.

## Machine navigation

### Facing angle compass

The orientation and colour of the facing angle compass's arrow shows the operator the facing angle of the bucket edge relative to the target surface.



This allows the bucket edge to be accurately positioned square with the target surface, which is useful when finishing slopes.

### Enhanced operability of the machine control

Semi-auto/manual mode switching and design surface offset function can be operated with switches on the control levers.

NEW



# Factory installed Komatsu intelligent Machine Control components



**Control box**  
A large, easy-to-view monitor and unique interface designed for Komatsu intelligent Machine Control excavators.



GNSS antennae

GNSS receiver



**Stroke sensing hydraulic cylinders**

Integrated stroke sensing cylinders provide accurate real time bucket position which is immediately displayed on the control box providing increased productivity and accuracy.



**Inertial Measurement Unit (IMU)**

The IMU detects machine pitch and roll for highly accurate finishing work regardless of ground condition.



**Auto-tilt attachment control**

## Standard local options providing first 12 months support:

(includes: Standard 3G/4G modem with DATA & SIM, industry leading ICT machine OEM service support agreement with iMC 2.0)



### Remote control

Assist the operator by taking control of their GNSS equipment in real-time.



### File transfer history

Overview of when, and which, files have been transferred.



### Remote view

Real-time remote image of the GNSS equipment.



### Office to machine transfer

Send the latest design files from the office to your machines.



### Machine to office transfer

Download files that have been collected on your system (survey results, as-built data, ...)



### Offline file transfer

Machine offline? No issue. Files are stored in cloud, operator will see updated model at machine switch on.



### Batch file transfer

Send files to multiple machines in one click.





## Work smarter from rough digging to finish grade

Give your operators the power to work more effectively than with conventional aftermarket machine guidance (indicate only) or manual operation. Intelligent Machine Control (iMC) excavators with semi-automatic control offer the capability to work smart from rough digging to finish grading, and help minimise over-excavation to make every pass count.

- Semi-automatic for trenching, slope work and high production applications
- Protection + precision + performance = the formula for pursuing maximum productivity versus conventional machine guidance



Photos may include overseas specification.

# Working smarter in every way

## Benefits of iMC 2.0



### Save money

Frees GPS Dozer from need to achieve final grade so it can work elsewhere on the site.



### Save time

Reduce staking, grading and inspection with 3D design data and semi-automatic grading.

Photo may include overseas specification.

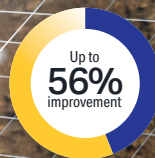

### Less time grade checking

Monitor performance and stay on grade from the cab: operators spend time working, not grade checking.

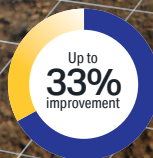

### Improve accuracy

Continuously monitor grade and semi-automatics to dig precisely to grade.

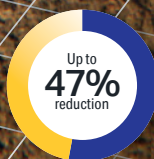

### Reduce base aggregate

Greatly reduce over-digging and the amount of costly base aggregate needed for applications like utilities.

*\*All savings, improvements, and reductions are compared to traditional grading methods.*

## Maintenance features



PC290LCi-11 shown.

## Large capacity air cleaner

The larger air cleaner can extend air cleaner life during long-term operation and helps prevent early clogging, and resulting power loss. A radial seal design is used for reliability.



## Engine Access

Large rear opening hood provides excellent maintenance and service access to key engine components.



## Fuel Filters

Large high-efficiency fuel filter and pre-filter with water separator removes contaminants from fuel for improved fuel injection system life.



High efficiency fuel filter      Fuel pre-filter (with water separator)

## Easy access to engine oil filter and fuel drain valve

Engine oil filter and fuel drain valve are remote mounted to improve accessibility.



## Battery isolation switch

A standard battery isolation switch allows a technician to disconnect the power supply and lock out before servicing the machine.



## Air conditioner filter

The air conditioner filter can be removed and installed without the use of tools for easy filter maintenance.

- Washable cab floormat**
- Sloping track frame**
- Long-life oils, filters**

Engine oil & Engine oil filter	every 500 hours
Hydraulic oil	every 5000 hours
Hydraulic oil filter	every 1000 hours

## DT-type connectors

Sealed DT-type electrical connectors provide high reliability, water and dust resistance.

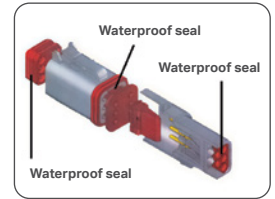

## Diesel Exhaust Fluid (DEF) tank

A large tank volume extends operating time before refilling and is installed on the right front platform for easy access. DEF tank and pump are separated for improved service access.

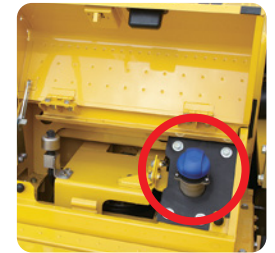

## Maintenance information

### "Maintenance time caution lamp" display

When the remaining time to maintenance becomes less than 30 hours\*, a maintenance time monitor appears. Pressing the F6 key switches the monitor to the maintenance screen.

\*: The setting can be changed within the range between 10 and 200 hours.



Maintenance screen

### Manual Stationary Regeneration

Under most conditions, active regeneration will occur automatically with no effect on machine operation. In case the operator needs to disable active regeneration or initiate a manual stationary regeneration, this can be easily accomplished through the monitor panel. A soot level indicator is displayed to show how much soot is trapped in the KDPP.

Soot level indicator



Aftertreatment device regeneration screen

### Supports the DEF level and refill timing

The DEF level gauge is displayed continuously on the right side of the monitor screen. In addition, when DEF level is low, DEF low level guidance messages appear in pop up displays to inform the operator in real time.

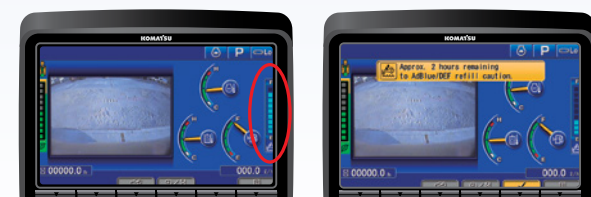

DEF level gauge

DEF low level guidance

## General features

### ROPS cab structure

#### ROPS Cab (ISO 12117-2)

The machine is equipped with a ROPS cab that conforms to ISO 12117-2 for excavators as standard equipment. It also satisfies the requirements for Level 1 Operator Protective Guard (OPG) and top guard (ISO 10262).



### Rear view monitoring system

A new rear view monitoring system display has a rear view camera image that is continuously displayed together with the gauges and important vehicle information. This enables the operator to carry out work while easily checking the surrounding area.

Rear view camera



Rear view image on monitor



### Low vibration with viscous cab mounts

The PC360LC-11 uses viscous mounts for the cab that incorporate a longer stroke and the addition of a spring. The cab damper mounting combined with a high rigidity deck reduces vibration at the operator's seat.

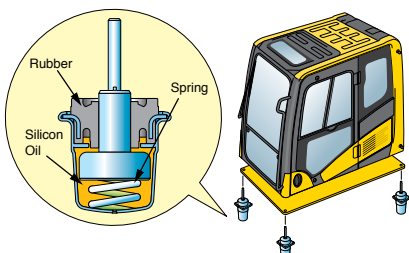

### General features

- Secondary engine shut down switch at base of seat to shutdown the engine
- Seat belt caution indicator



- Lock lever
- Retractable seat belt
- Tempered & tinted glass
- Large cab entrance step
- Left and right side hand rails
- Large mirrors
- Slip-resistant plates
- Thermal and fan guards
- Pump/engine compartment partition
- Travel alarm



# KALSS

## Australian standard specification



**Rotating amber beacon**  
Fitted with factory guard.



**Level indicator, overload alarm & anti-burst valves**  
Enable safety and compliance when lifting suspended loads.



**Additional lighting**  
Extra lighting on cab and counterweight for improved visibility.



**Proportional hand controls**  
Enables proportional hand control of attachment speed.



**Rock Guard**  
Reinforced steel plate and ribs to provide additional protection of arm structure.

**Higher Capacity Air Conditioner**  
With increased cool down performance.

**Bump Rails**  
For upper protection when slewing.

**Factory Fitted Quick Hitch and Hammer Piping**  
Enables use with a greater variety of attachments. Also fitted with provision for tilt circuit including valve.

**Heavy Duty Revolving Frame Under Covers**  
Protects and prevents ingress of material into engine bay.

**Full Length Track Roller Guards**  
Protects track roller against rock and debris damage.



**Lower Front Window Guard**  
Protects cabin windscreen against rocks and debris.



**Battery Isolation**  
Single pole, lockable Bosch-type battery isolation.



**E-Stops**  
Allow compliance to site safety requirements.



**Bolt-on Top Guard**  
OPG level 2 (ISO 10262) for falling object protection.

Specification also includes factory fitted provisions for fire extinguisher, turbo timer, UHF and vandal covers to reduce lead times and costs. Photos may include optional equipment.

# Specifications

## Engine

Model	Komatsu SAA6D114E-6*	
Type	Water-cooled, 4-cycle, direct injection	
Aspiration	Variable geometry turbocharged, aftercooled, cooled EGR	
Number of cylinders	6	
Bore	<b>114 mm</b> 4.49"	
Stroke	<b>144.5 mm</b> 5.69"	
Piston displacement	<b>8.85 ltr</b> 540 in <sup>3</sup>	
Horsepower:		
SAE J1995	Gross	<b>202 kW</b> 271 HP
ISO 9249 / SAE J1349	Net	<b>192 kW</b> 257 HP
Rated rpm	1950	
Governor	All-speed control, electronic	
Fan drive method for radiator cooling	Mechanical	
*EPA Tier 4 Final emissions certified		

## Hydraulics

Type	HydrauMind (Hydraulic Mechanical Intelligence system, closed-centre system with load sensing valve and pressure compensated valves)		
Number of selectable working modes	6		
Main pump:			
Pumps for	Boom, arm, bucket, swing, and travel circuits		
Type	Variable displacement axial piston type		
Maximum flow	535 ltr/min 141.3 gal/min		
Supply for control circuit	Self reducing valve		
Relief valve setting:			
Implement circuits	<b>37.3 MPa</b>	<b>5380 kgf/cm<sup>2</sup></b>	5,400 psi
Travel circuit	<b>37.3 MPa</b>	<b>5380 kgf/cm<sup>2</sup></b>	5,400 psi
Swing circuit	<b>27.9 MPa</b>	<b>5285 kgf/cm<sup>2</sup></b>	4,050 psi
Pilot circuit	<b>3.2 MPa</b>	<b>533 kgf/cm<sup>2</sup></b>	470 psi
Hydraulic cylinders:			
(Number of cylinders – bore x stroke x rod diameter)			
Boom	<b>2–140 mm x 1480 mm x 100 mm</b>	5.5" x 58.3" x 3.9"	
Arm	<b>1–160 mm x 1825 mm x 110 mm</b>	6.3" x 71.9" x 4.3"	
Bucket	<b>1–140 mm x 1285 mm x 100 mm</b>	5.5" x 50.6" x 3.9"	

## Drives and brakes

Steering control	Two lever with pedals	
Drive method	Hydrostatic	
Maximum drawbar pull	290 kN 29570 kgf 65,191 lbf	
Gradeability	70%, 35°	
Maximum travel speed (auto shift):		
High	<b>5.5 km/h</b> 3.4 mph	
Mid	<b>4.2 km/h</b> 2.8 mph	
Low	<b>3.2 km/h</b> 2.0 mph	
Service brake	Hydraulic lock	
Parking brake	Mechanical disc brake	

## Swing system

Driven by	Hydraulic motor
Swing reduction	Planetary gear
Swing circle lubrication	Grease-bathed
Service brake	Hydraulic lock
Holding brake/Swing lock	Mechanical disc brake
Swing speed	9.5 rpm
Swing torque	<b>11386 kg•m</b> 82,313 ft lbs

## Undercarriage

centre frame	X-frame
Track frame	Box-section
Track type	Sealed
Track adjuster	Hydraulic
Number of shoes (each side)	48
Number of carrier rollers (each side)	2
Number of track rollers (each side)	8

## Coolant & lubricant capacity (Refilling)

Fuel tank	<b>605 ltr</b> 159.8 U.S. gal
Radiator	<b>37 ltr</b> 9.7 U.S. gal
Engine	<b>35 ltr</b> 9.2 U.S. gal
Final drive, each side	<b>9.0 ltr</b> 2.4 U.S. gal
Swing drive	<b>13.7 ltr</b> 3.6 U.S. gal
Hydraulic tank	<b>188 ltr</b> 49.7 U.S. gal
Diesel Exhaust Fluid (DEF) tank	<b>39 ltr</b> 10.3 U.S. gal

## Operating weight (approximate)

Operating weight includes **6500 mm** one-piece HD boom, **3200 mm** HD arm, rated capacity of lubricants, coolant, full fuel tank, operator, standard equipment, KGA dual lock quick hitch, and SAE heaped **1.80 m<sup>3</sup>** bucket.

Triple-grouser shoes	Operating weight	Ground pressure
<b>600 mm</b>	<b>36,490 kg</b>	<b>0.69 kg/cm<sup>2</sup></b>
<b>700 mm</b>	<b>36,870 kg</b>	<b>0.60 kg/cm<sup>2</sup></b>
<b>850 mm</b>	<b>37,440 kg</b>	<b>0.50 kg/cm<sup>2</sup></b>

## Component weights

Arm including bucket cylinder and linkage:		
<b>3200 mm</b> HD arm assembly	<b>1761 kg</b>	3,882 lb
One piece HD boom including arm cylinder:		
<b>6500 mm</b> boom assembly	<b>3135 kg</b>	6,912 lb
Boom cylinders x 2	<b>259 kg</b>	571 lb
Counterweight	<b>6920 kg</b>	15,255 lb

# PC360LC11 / PC360LCi-11

## Dimensions

	Undercarriage	3200 mm
A	Overall length	11145 mm
B	Length on ground (transport)	5935 mm
C	Overall height (to top of boom)*	3285 mm
D	Overall width	3190 mm
E	Overall height (to top of cab)*	3160 mm
F	Overall height (to top of handrail)*	3255 mm
G	Ground clearance, counterweight	1185 mm
H	Ground clearance, minimum	498 mm
I	Tail swing radius	3445 mm
J	Track length on ground	4030 mm
K	Track length	4955 mm
L	Track gauge	2590 mm
M	Width of crawler	3190 mm
N	Shoe width	600 mm
O	Grouser height	36 mm
P	Machine height to top of engine cover	3135 mm
Q	Machine upper width**	3145 mm
R	Distance, swing centre to rear end	3405 mm

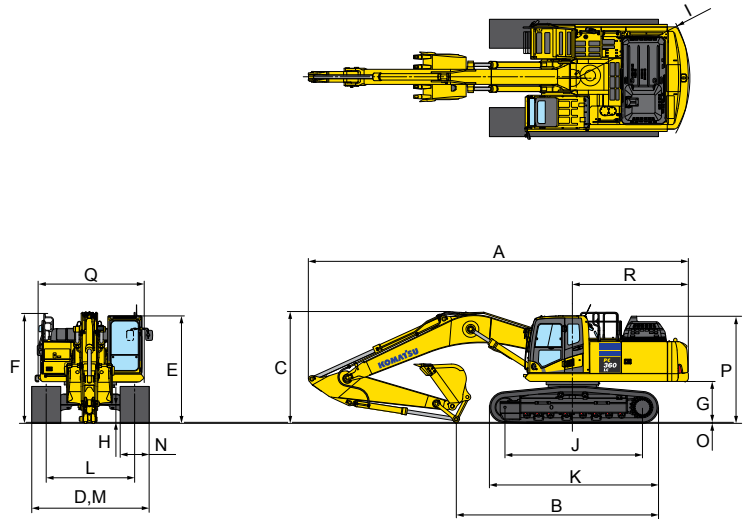

## Working range

Arm Length	3200 mm	
A	Max. digging height	10210 mm
B	Max. dumping height	7110 mm
C	Max. digging depth	7380 mm
D	Max. vertical wall digging depth	6480 mm
E	Max. digging depth for 8' level bottom	7180 mm
F	Max. digging reach	11100 mm
G	Max. digging reach at ground level	10920 mm
H	Min. swing radius	4310 mm
SAE rating:		
Bucket digging force at power max.	200 kN 20400 kg	
Arm crowd force at power max.	165 kN 16800 kg	
ISO rating:		
Bucket digging force at power max.	228 kN 23200 kg	
Arm crowd force at power max.	171 kN 17400 kg	

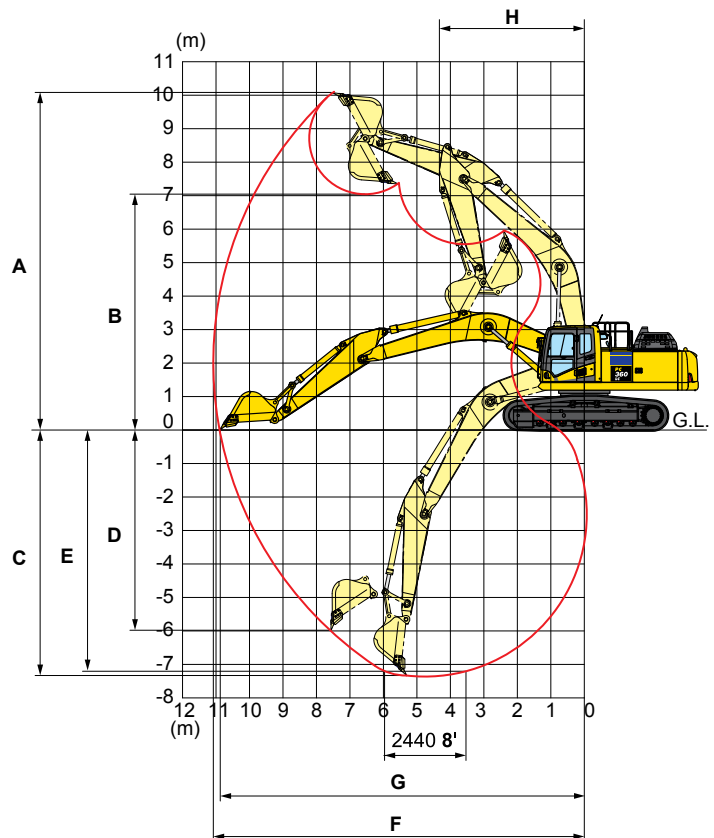



## Lift capacities

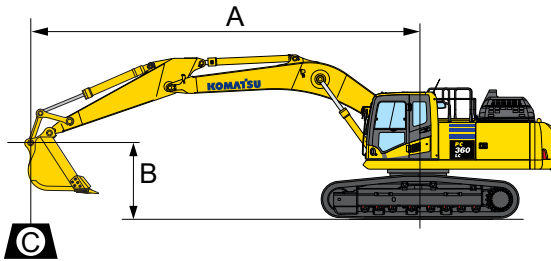

### Lifting capacity with lifting mode

A:	Reach from swing centre
B:	Bucket hook height
C:	Lifting capacity
Cf:	Rating over front
Cs:	Rating over side
⊗:	Rating at maximum reach

### Conditions:

Boom length:	6500 mm
Arm length:	3200 mm
Shoes:	600 mm triple grouser
Bucket:	1014 kg

A/B	3.0 m		4.5 m		6.0 m		7.5 m		Unit: kg ⊗ MAX	
	Cf	Cs	Cf	Cs	Cf	Cs	Cf	Cs	Cf	Cs
6.0 m	-	-	-	-	-	-	*7150	6850	*5200	5150
4.5 m	-	-	-	-	*9050	*9050	*7700	6600	*5350	4500
3.0 m	-	-	*14800	14100	*10500	9000	*8500	6300	*5650	4150
1.5 m	-	-	*16450	13050	*11800	8500	*9150	6000	*6200	4000
0.0 m	*8100	*8100	*17250	12500	*12400	8100	9400	5800	6650	4050
-1.5 m	*9550	*9550	*16750	12400	*12350	7950	9300	5650	7150	4350
-3.0 m	*17650	*17650	*15250	12550	*11500	7950	*8750	5650	*7550	5000
-4.5 m	*16250	*16250	*12600	*12600	*9550	8150	-	-	*7350	6450
-6.0 m	-	-	-	-	-	-	-	-	*6100	*6100

\* Load is limited by hydraulic capacity rather than tipping. Ratings are based on SAE standard No. J1097.  
Rated loads do not exceed 87% of hydraulic lift capacity or 75% of tipping load.



## Standard equipment

- 3 speed travel with auto shift
- Access handrails – counterweight
- Alternator, 90 A, 24 V
- Arm, 3200 mm
- Auto idle
- Auto idle shut down
- Automatic air conditioner, large capacity
- Automatic engine warm-up system
- Auxiliary input (3.5 mm jack)
- Batteries, large capacity
- Battery isolation switch, lockable
- Boom, 6500 mm
- Boom and arm burst valve protection
- Bump rails
- Cab guards
  - Lower front window guard
  - Integrated top guard, OPG Level 1
  - Bolt on top guard, OPG Level 2
- Carrier rollers, (2 each side)
- Converter, (2) x 12 V
- Counterweight, 6920 kg
- Dry type air cleaner, double element
- Dual flow hammer piping
- Electric horn
- Emergency stops (3)
- EMMS monitoring system
- Engine, Komatsu SAA6D107E-3
- Fan guard structure
- Fire extinguisher, 1.5 kg (for PC360LCi-11)
- Fuel system pre-filter 10 micron
- Guard belly plate (for PC360LCi-11)
- High back air suspension seat, with heat
- High pressure in-line hydraulic filters
- Hydraulic track adjusters
- Hydraumind closed centre load sensing system
- KOMTRAX
- Komvision (Standard on all models manufactured after August 2021)
- Large LCD colour monitor, high resolution
- Level indicator
- Lock lever
- Lock lever, auto-lock
- Mirrors (LH, RH & sidewise)
- Operator identification system (available August 2021)
- Overload alarm
- Power maximising system
- PPC hydraulic control system
- Proportional control handles
- Provision for tilt circuit, including valve
- Pump/engine room partition cover
- Quick hitch piping with safety switch and alarm
- Radiator and oil cooler dustproof net
- Radio Bluetooth USB media system
- Rear reflectors
- Revolving frame undercovers
- ROPS cab (ISO 12117-2) with vandal guard provisions
- Rearview monitoring system (1 camera) (For PC360LC-11 models manufactured before August 2021)
- Rotating beacon (LED) with guard
- Seat belt indicator
- Seat belt, retractable, 78 mm
- Secondary engine shutdown switch
- Side access hand rails
- Side by side coolers
- Slip resistant foot plates
- Starter motor, 11 kW/24 V x 1
- Suction fan
- Thermal and fan guards
- Track roller guides, 3 each side
- Track rollers, 8 each side
- Track frame swivel guard
- Track shoes, triple grouser, 600 mm
- Travel alarm
- Turbo timer
- Working lights
  - 1 x boom
  - 1 x RH
  - 3 x cab
  - 1 x counterweight
- Working mode selection system

## intelligent Machine Control

- 12 month remote access to your machine (includes data & SIM)
- 12 months service level support agreement
- Auto grade assist
- Auto stop control boom and bucket
- Auto tilt attachment control [when tilt bucket fitted]
- Bucket angle hold
- Dual multi-constellation GNSS antennas
- Excavator weighing system
- Factory integrated 3D machine control
- iMC 2.0 canvas seat cover
- Komatsu chassis mounted iMU
- Komatsu PH700 monitor
- Komatsu stroke sensors [boom/arm & bucket]
- MC-i4 with internal 4G modem
- Minimum distance control
- Network and UHF antennas
- Receiver- UR-1 UHF and 915SS radio

## Optional equipment

- Autogrease system
- Battery isolation switch, dual pole, lockable
- Belly plates, 8 mm
- Cab guard
  - Full front guard, OPG Level 2
- Cab vandal guard set
- Canvas seat cover
- Fire extinguisher, 1.5 kg
- Fire extinguisher, 4.5 kg
- Fire extinguisher, 9 kg
- Fuel cap vandal guard
- Jump start receptacle
- Radio 915SS
- Starter circuit isolation, lockable
- Track shoes, triple grouser, 700 mm
- Track shoes, triple grouser, 850 mm
- Window tinting

## Attachment options

- Bucket, general purpose, KGA 650 mm, 0.53 m<sup>3</sup>
- Bucket, general purpose, KGA 1300 mm, 1.35 m<sup>3</sup>
- Bucket, general purpose, KGA 1500 mm, 1.61 m<sup>3</sup>
- Bucket, general purpose, KGA 1700 mm, 1.80 m<sup>3</sup>
- Bucket, rock, direct pin, KGA 1600 mm, 1.66 m<sup>3</sup>
- Bucket, slope finishing, KGA 2200 mm, 2.20 m<sup>3</sup>
- Quick hitch, KGA, dual lock
- Ripper, KGA, single tyne

## Now available

### Komatsu JMHB360H-1 Hydraulic Breaker



Model Type	JMHB360H-1	
Working weight	kg	2,571
Oil flow (min - max)	ℓ /min	175 - 250
Operating pressure (max)	MPa	155
Impact rate	bpm	320 - 560
Chisel diameter	mm	160
Variable frequencies	-	2 Auto
Acceptable back pressure	bar	25
Base machine (min - max)	Ton	27 - 40

For a complete list of available attachments, please contact your local Komatsu representative.

# Notes

---

Product designs, specifications and/or data in this document are provided for informational purposes only and are not warranties of any kind. Product designs and/or specifications may be changed at any time without notice. The only warranties that apply to sales of products and services are Komatsu's standard written warranties, which will be furnished upon request.

Komatsu and other trademarks and service marks used herein are the property of Komatsu Ltd., Komatsu Australia Pty Ltd., Komatsu America Corp., Komatsu Mining Corp., or one of their affiliates, or the respective owners or licensees.

**KOMATSU**

[komatsu.com.au](https://www.komatsu.com.au)

