

KOMATSU®

PC360LC-11

EPA Tier 4 Final Engine

Australia & New Zealand Specifications

HYDRAULIC EXCAVATOR



Photos may include optional equipment.

NET HORSEPOWER

192 kW / 257 HP@1950 rpm

OPERATING WEIGHT

35,950 – 37,440 kg

BUCKET CAPACITY

0.53 – 1.80 m³

PC360LC

WALK-AROUND

PC360LC-11



Photos may include optional equipment.

NET HORSEPOWER

192 kW / 257 HP @ 1950 rpm

OPERATING WEIGHT

35,950 – 37,440 kg

BUCKET CAPACITY

0.53 – 1.80 m³

GREATER PERFORMANCE & FASTER CYCLE TIMES

Komatsu's Closed-centre Load Sensing System (CLSS) provides quick response and smooth operation to maximise productivity.

New engine and hydraulic control technology improves operational efficiency and lowers fuel consumption by up to 11%

A powerful Komatsu SAA6D114E-6 engine provides a net output of 192 kW 257 HP. This engine is EPA Tier 4 Final emissions certified.

Komatsu Variable Geometry Turbocharger (KVGIT) uses a hydraulic actuator to provide optimum air flow under all speed and load conditions.

Komatsu Diesel Particulate Filter (KDPF) and Selective Catalytic Reduction (SCR) system reduce particulate matter and NOx while providing automatic regeneration that does not interfere with daily operation.

Large displacement high efficiency pumps provide high flow output at lower engine speed, improving efficiency.

Two boom mode settings provide power mode for maximum digging force or smooth mode for fine grading operations.

KOMTRAX® equipped machines can send location, SMR and operation maps to a secure website or smart phone utilising wireless technology. Machines also relay error codes, cautions, maintenance items, fuel & Diesel Exhaust Fluid (DEF) levels, and much more.

Large LCD colour monitor:

- 7" high resolution display
- Enhanced hydraulic attachment control with one way/two way flow and programmable work tool names and settings
- Key machine settings and controls easily accessible through the monitor

Rearview monitoring system (standard) with integrated camera display in the default monitor screen.

Six working modes are designed to match engine speed, pump delivery and system pressure to the application.



Enhanced working environment

- High back, heated air suspension seat with adjustable arm rests
- Integrated ROPS cab design
- Cab meets ISO Level 1 Operator Protective Guard (OPG) top guard
- Auxiliary jack and (2) 12V power outlets
- Auto climate control

Komatsu designed and manufactured components

Handrails (standard) located on the machine upper structure provide a convenient work area in front of the engine.

Lockable single pole battery isolation switch allows a technician to disconnect the power supply before servicing the machine.

Heavy duty boom design with large one piece castings provide increased strength and durability.

Komatsu Auto Idle Shutdown helps reduce nonproductive engine idle time and reduces operating costs.

Operator Identification System records KOMTRAX® machine operation and application data for up to 100 individual ID codes.

PERFORMANCE FEATURES

KOMATSU NEW ENGINE TECHNOLOGIES

Komatsu's New Emission Regulations-compliant Engine

New regulations effective in 2018 require the reduction of NOx emissions to one tenth or below from the preceding regulations. In addition to refining the Tier 4 Interim technologies, Komatsu has developed a new Selective Catalytic Reduction (SCR) device in-house.

Technologies Applied to New Engine

Heavy-duty aftertreatment system

This new system combines a Komatsu Diesel Particulate Filter (KDPF) and Selective Catalytic Reduction (SCR). The SCR NOx reduction system injects the correct amount of Diesel Exhaust Fluid (DEF) at the proper rate, thereby decomposing NOx into non-toxic water vapour (H₂O) and nitrogen gas (N₂).

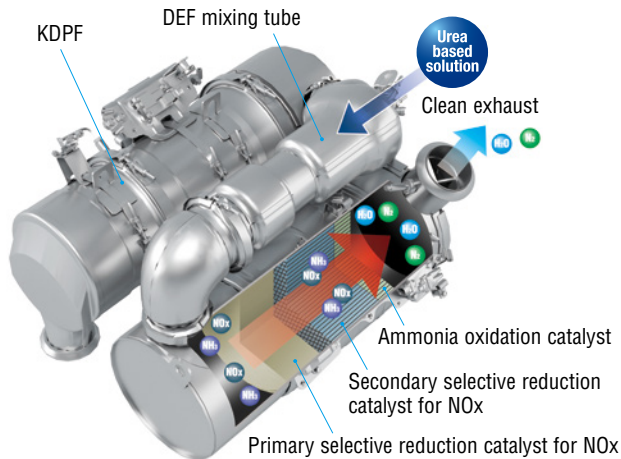

Heavy-duty cooled Exhaust Gas Recirculation (EGR) system

The system recirculates a portion of exhaust gas into the air intake and lowers combustion temperatures, thereby reducing NOx emissions. EGR gas flow has been decreased for Tier 4 Final with the addition of SCR technology. The system achieves a dynamic reduction of NOx, while helping reduce fuel consumption below Tier 4 Interim levels.

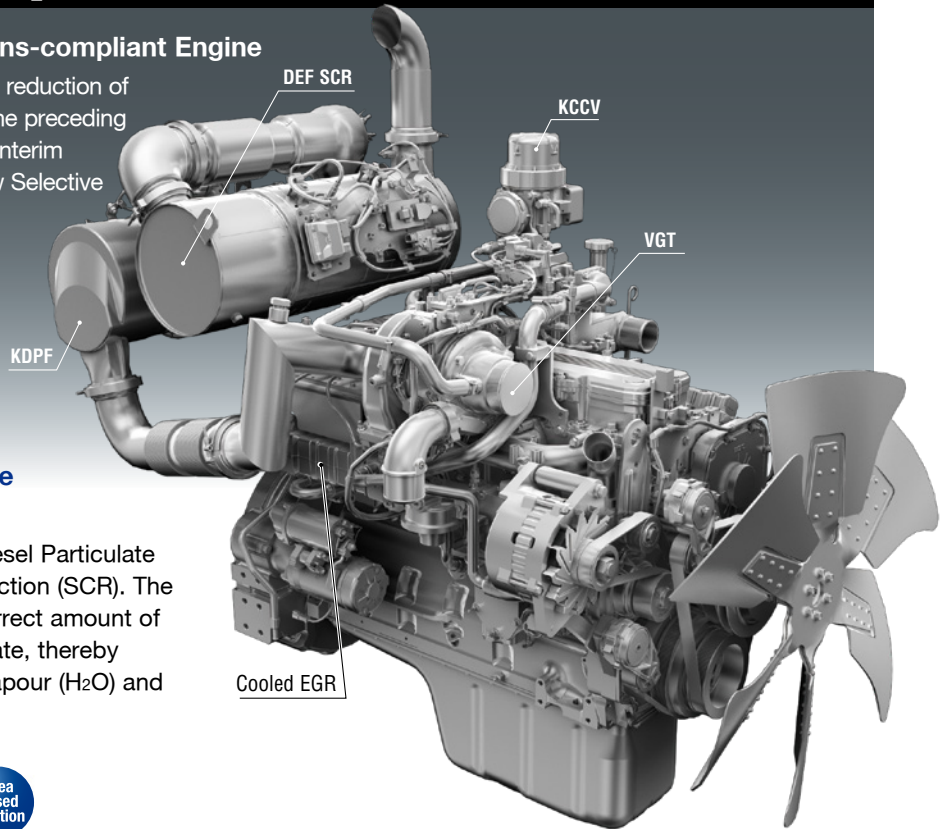
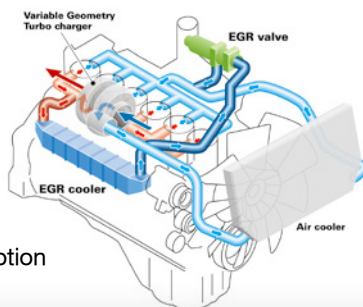

Advanced Electronic Control System

The electronic control system performs high-speed processing of all signals from sensors installed in the vehicle providing total control of equipment in all conditions of use. Engine condition information is displayed via an on-board network to the monitor inside the cab, providing necessary information to the operator. Additionally, managing the information via KOMTRAX helps customers keep up with required maintenance.

Komatsu Variable Geometry Turbocharger (KVT) system

The VGT system features proven Komatsu design hydraulic technology for variable control of air-flow and supplies optimal air according to load conditions. The upgraded version provides better exhaust temperature management.

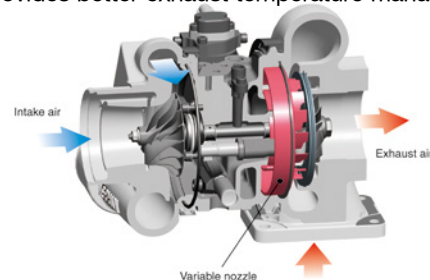

Komatsu Auto Idle Shutdown

Komatsu auto idle shutdown automatically shuts the engine down after idling for a set period of time to reduce unnecessary fuel consumption and exhaust emissions.



Heavy-Duty High-Pressure Common Rail (HPCR) Fuel Injection System

The system is designed to achieve an optimal injection of high-pressure fuel by means of Computerised control, providing close to complete combustion to reduce PM emissions. While this technology is already used in current engines, the new system uses high pressure injection, thereby reducing both PM emissions and fuel consumption over the entire range of engine operating conditions. The Tier 4 Final engine has advanced fuel injection timing for reduced fuel consumption and lower soot levels.

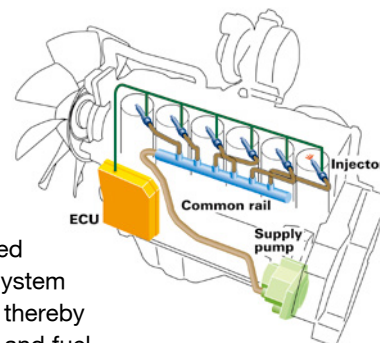

PERFORMANCE FEATURES

Reduced Fuel Consumption

The PC360LC-11's new tier 4 final engine along with enhancements in the hydraulic system considerably decreases fuel consumption.

Fuel Consumption

Reduced by 11%

(vs PC350LC-8M0 Based on typical work pattern collected via KOMTRAX)

This fuel consumption data is the result compared actual measured value using the prototype machine.

Increased Work Efficiency

Large digging force

With the one-touch Power Max. function, digging force is increased for 8.5 seconds of operation.

Maximum arm crowd force (ISO)

160 kN(16.3t) ➔ 171 kN(17.4t) 7% UP
(With Power Max.)

Maximum bucket digging force (ISO)

213 kN(21.7t) ➔ 228 kN(23.2t) 7% UP
(With Power Max.)

Measured with Power Max. function, 3200 mm arm and ISO rating

Faster arm cycle speeds

Two return hoses improve arm cylinder hydraulic flow for faster arm out performance.

Two-mode settings for boom

- Smooth boom mode reduces boom down force for working on hard surfaces or for hydraulic hammer operation.
- Power boom mode maximises digging force for more effective excavating

Lifting mode

When the Lifting mode is selected, lifting capacity is increased 7% by raising hydraulic pressure.



PC360LC-11

Drawbar Pull

The Komatsu designed final drives and undercarriage provide high drawbar pull for good maneuverability and performance when working on adverse grades or soft ground.



Efficient Hydraulic System

The PC360LC-11 uses a Closed-centre Load Sensing System (CLSS) that improves fuel efficiency and provides quick response to the operator's demands. The PC360LC-11 also incorporates new technology to enhance the engine and hydraulic pump control. This total control system matches the engine and hydraulics at the most efficient point under any load condition. There have also been improvements in the main valve and hydraulic circuit to reduce hydraulic loss, resulting in higher efficiency and lower fuel consumption.

Large Displacement High Efficiency Pump

Large displacement hydraulic implement pumps provide high flow output at lower engine RPM as well as operation at the most efficient engine speed.



Working Mode Selection

The PC360LC-11 excavator is equipped with six working modes (P, E, L, B, ATT/P and ATT/E). Power Mode provides improved hydraulic power and faster cycle times for improved performance in demanding applications. Each mode is designed to match engine speed, pump flow, and system pressure to the application. The PC360LC-11 features an attachment mode (ATT/E) that allows operators to run attachments while in Economy mode.

Working Mode	Application	Advantage
P	Power Mode	•Maximum production, power & multifunction
E	Economy Mode	•Good cycle times with reduced fuel consumption
L	Lifting Mode/ Fine Control	•Increased lifting power & fine control
B	Breaker Mode	•One way flow for hydraulic breaker operation
ATT/P	Attachment Power Mode	•Two way flow with maximum power
ATT/E	Attachment Economy Mode	•Two way flow with most efficient fuel economy

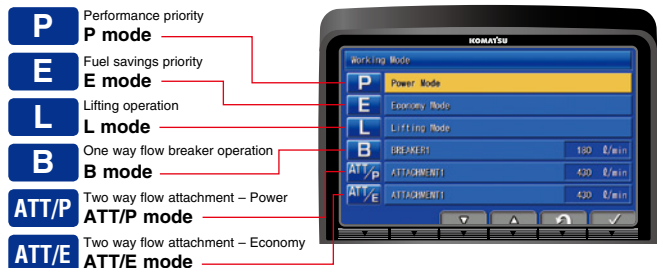

High Rigidity Work Equipment

Booms and arms are constructed with thick plates of high tensile strength steel. In addition, these structures are designed with large cross sectional areas and large one piece castings in the boom foot, the boom tip, and the arm tip. The result is work equipment that exhibits long term durability and high resistance to bending and torsional stress. A standard HD boom design provides increased strength and reliability.

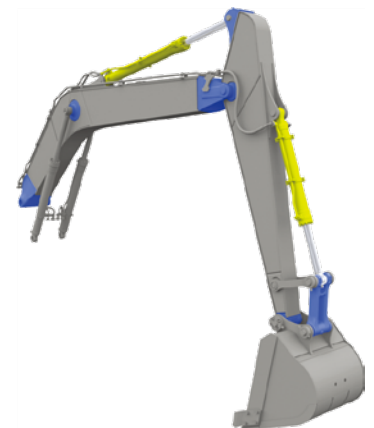

WORKING ENVIRONMENT

PC360LC-11





Comfortable Working Space

Wide spacious cab

Wide spacious cab includes seat with reclining backrest. The seat height and longitudinal inclination are easily adjusted using a pull-up lever. You can set the appropriate operational posture of armrest together with the console. Reclining the seat further enables you to place it into the fully flat state with the headrest attached.

Arm rest with simple height adjustment function

The addition of a knob and a plunger to the armrest permits the height of the armrest to be easily adjusted without the use of tools.



Low vibration with cab damper mounting

Automatic climate control

Pressurised cab

Auxiliary input jack

Connecting a regular audio device to the auxiliary jack allows the operator to hear the sound from the speakers installed in the cab.



Standard Equipment

Sliding window glass (left side)



AM/FM stereo radio



Remote intermittent wiper with windshield washer

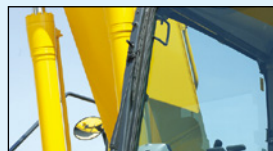

Emergency stop & level indicator



ISO Level 2 OPG



Magazine box & cup holder



Defroster (conforms to the ISO standard)



One-touch storable front window lower glass

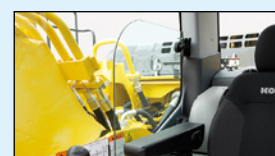

WORKING ENVIRONMENT

PC360LC-11

LARGE HIGH RESOLUTION LCD MONITOR



New Monitor Panel Interface Design

An updated large high resolution LCD colour monitor enables accurate and smooth work. The interface has been redesigned to display key machine information in a new user friendly interface. A rear view camera and a DEF level gauge display have been added to the default main screen. The interface has a function that enables the main screen mode to be switched, thus enabling the optimum screen information for the particular work situation to be displayed.

Indicators

- | | |
|------------------------------------|-----------------------------|
| 1 Auto-decelerator | 8 Fuel gauge |
| 2 Working mode | 9 DEF level gauge |
| 3 Travel speed | 10 Service metre, clock |
| 4 Ecology gauge | 11 Fuel consumption gauge |
| 5 Camera display | 12 Guidance icon |
| 6 Engine coolant temperature gauge | 13 Function switches |
| 7 Hydraulic oil temperature gauge | 14 Camera direction display |
| | 15 DEF level caution lamp |

Basic operation switches

- | | |
|-------------------------|-------------------------|
| 1 Auto-decelerator | 4 Buzzer cancel |
| 2 Working mode selector | 5 Wiper |
| 3 Travel speed selector | 6 Window washer |
| | 7 Auto climate controls |

Switchable Display Modes

The main screen display mode can be changed by pressing the pressing the F3 key.

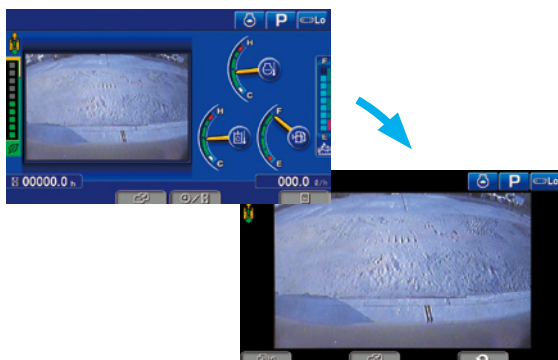

Visual user menu

Pressing the F6 key on the main screen displays the user menu screen. The menus are grouped for each function, and use easy-to-understand icons which enable the machine to be operated easily.



- | | |
|---------------------------------------|--------------------|
| 1 Energy saving guidance | 2 Machine settings |
| 3 Aftertreatment devices regeneration | 4 SCR information |
| 5 Maintenance | 6 Monitor setting |
| 7 Message check | |

Support Efficiency Improvement

Ecology guidance

While the machine is operating, ecology guidance pops up on the monitor screen to notify the operator of the status of the machine in real time.

Ecology gauge & fuel consumption gauge

The monitor screen is provided with an ecology gauge and also a fuel consumption gauge which is displayed continuously. In addition, the operator can set any desired target value of fuel consumption (within the range of the green display), enabling the machine to be operated with better fuel economy.



Ecology gauge Fuel consumption gauge
Ecology guidance

Operation record, fuel consumption history, and ecology guidance record

The ecology guidance menu enables the operator to check the operation record, fuel consumption history and ecology guidance record from the ecology guidance menu, using a single touch, thus enabling the total fuel consumption to be reduced.



Operation record



Fuel consumption history

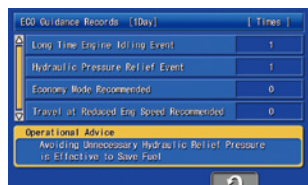

Ecology guidance record

Operator Identification Function

An identification ID can be set up for individual operator, application or jobs, and used to manage operation information of individual machines using KOMTRAX data. Data sent from KOMTRAX can be used to analyse operation status by operator as well as by machine.



MAINTENANCE FEATURES

PC360LC-11



Large capacity air cleaner

The larger air cleaner can extend air cleaner life during long-term operation and helps prevent early clogging, and resulting power loss. A radial seal design is used for reliability.



Engine Access

Large rear opening hood provides excellent maintenance and service access to key engine components.



Fuel Filters

Large high-efficiency fuel filter and pre-filter with water separator removes contaminants from fuel for improved fuel injection system life.



High efficiency fuel filter Fuel pre-filter (with water separator)

Easy access to engine oil filter and fuel drain valve

Engine oil filter and fuel drain valve are remote mounted to improve accessibility.



Battery isolation switch

A standard battery isolation switch allows a technician to disconnect the power supply and lock out before servicing the machine.



Air conditioner filter

The air conditioner filter can be removed and installed without the use of tools for easy filter maintenance.

Washable cab floormat

Sloping track frame

Long-life oils, filters

Engine oil & Engine oil filter	every 500 hours
Hydraulic oil	every 5000 hours
Hydraulic oil filter	every 1000 hours

DT-type connectors

Sealed DT-type electrical connectors provide high reliability, water and dust resistance.

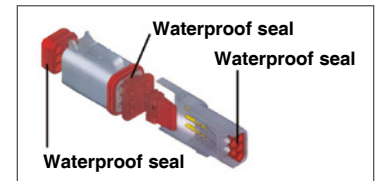

Diesel Exhaust Fluid (DEF) tank

A large tank volume extends operating time before refilling and is installed on the right front platform for easy access. DEF tank and pump are separated for improved service access.

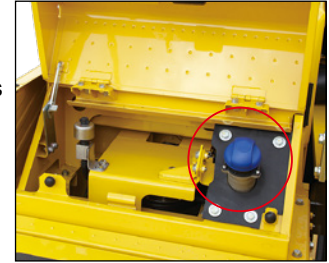

MAINTENANCE INFORMATION

“Maintenance time caution lamp” display

When the remaining time to maintenance becomes less than 30 hours*, a maintenance time monitor appears. Pressing the F6 key switches the monitor to the maintenance screen.

* : The setting can be changed within the range between 10 and 200 hours.



Maintenance screen

Manual Stationary Regeneration

Under most conditions, active regeneration will occur automatically with no effect on machine operation. In case the operator needs to disable active regeneration or initiate a manual stationary regeneration, this can be easily accomplished through the monitor panel. A soot level indicator is displayed to show how much soot is trapped in the KDPF.



Soot level indicator

Aftertreatment device regeneration screen

Supports the DEF level and refill timing

The DEF level gauge is displayed continuously on the right side of the monitor screen. In addition, when DEF level is low, DEF low level guidance messages appear in pop up displays to inform the operator in real time.

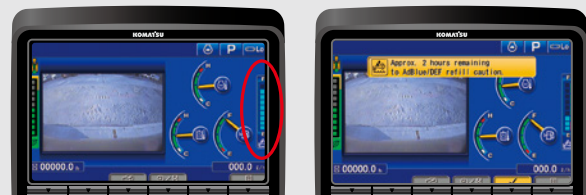

DEF level gauge

DEF low level guidance

GENERAL FEATURES

ROPS CAB STRUCTURE

ROPS Cab (ISO 12117-2)

The machine is equipped with a ROPS cab that conforms to ISO 12117-2 for excavators as standard equipment. It also satisfies the requirements for Level 1 Operator Protective Guard (OPG) and top guard (ISO 10262).



Rear View Monitoring System

A new rear view monitoring system display has a rear view camera image that is continuously displayed together with the gauges and important vehicle information. This enables the operator to carry out work while easily checking the surrounding area.

Rear view camera



Rear view image on monitor



Low Vibration with Viscous Cab Mounts

The PC360LC-11 uses viscous mounts for the cab that incorporate a longer stroke and the addition of a spring. The cab damper mounting combined with a high rigidity deck reduces vibration at the operator's seat.

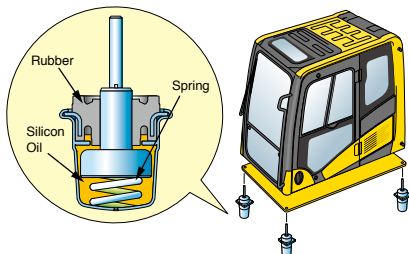

GENERAL FEATURES

Secondary engine shut down switch at base of seat to shutdown the engine.



Seat belt caution indicator



Large mirrors

Slip-resistant plates

Thermal and fan guards

Pump/engine compartment partition

Travel alarm

Lock lever

Retractable seat belt

Tempered & tinted glass

Large cab entrance step

Left and right side hand rails



KALSS AUSTRALIAN STANDARD SPECIFICATION



Rotating Amber Beacon

Fitted with factory guard.



Level Indicator, Overload Alarm & Anti-Burst Valves

Enable safety and compliance when lifting suspended loads.



Additional Lighting

Extra lighting on cab and counterweight for improved visibility.



Proportional Hand Controls

Enables proportional hand control of attachment speed.



Rock Guard

Reinforced steel plate and ribs to provide additional protection of arm structure.

Higher Capacity Air Conditioner

With increased cool down performance.

Factory Fitted Quick Hitch and Hammer Piping

Enables use with a greater variety of attachments. Also fitted with provision for tilt circuit including valve.

Bump Rails

For upper protection when slewing.

Full Length Track Roller Guards

Protects track roller against rock and debris damage.

Heavy Duty Revolving Frame Under Covers

Protects and prevents ingress of material into engine bay.



Lower Front Window Guard

Protects cabin windscreen against rocks and debris.



Battery Isolation

Single pole, lockable Bosch-type battery isolation.



E-Stops

Allow compliance to site safety requirements.



Bolt-on Top Guard

OPG level 2 (ISO 10262) for falling object protection.

Specification also includes factory fitted provisions for fire extinguisher, turbo timer, UHF and vandal covers to reduce lead times and costs. Photos may include optional equipment.

SPECIFICATIONS



ENGINE

Model..... Komatsu SAA6D114E-6*
 Type..... Water-cooled, 4-cycle, direct injection
 Aspiration..... Variable geometry turbocharged, aftercooled, cooled EGR
 Number of cylinders..... 6
 Bore..... **114 mm** 4.49"
 Stroke..... **144.5 mm** 5.69"
 Piston displacement..... **8.85 ltr** 540 in³
 Horsepower:
 SAE J1995..... Gross **202 kW** 271 HP
 ISO 9249 / SAE J1349..... Net **192 kW** 257 HP
 Rated rpm..... 1950
 Governor..... All-speed control, electronic
 Fan drive method for radiator cooling..... Mechanical
 *EPA Tier 4 Final emissions certified



HYDRAULICS

Type..... HydraMind (Hydraulic Mechanical Intelligence) system, closed-centre system with load sensing valve and pressure compensated valves
 Number of selectable working modes..... 6
 Main pump:
 Pumps for..... Boom, arm, bucket, swing, and travel circuits
 Type..... Variable displacement axial piston type
 Maximum flow..... **535 ltr/min** 141.3 gal/min
 Supply for control circuit..... Self reducing valve
 Hydraulic motors:
 Travel..... 2 x axial piston motors with parking brake
 Swing..... 1 x axial piston motor with swing holding brake
 Relief valve setting:
 Implement circuits..... **37.3 MPa 380 kgf/cm²** 5,400 psi
 Travel circuit..... **37.3 MPa 380 kgf/cm²** 5,400 psi
 Swing circuit..... **27.9 MPa 285 kgf/cm²** 4,050 psi
 Pilot circuit..... **3.2 MPa 33 kgf/cm²** 470 psi
 Hydraulic cylinders:
 (Number of cylinders – bore x stroke x rod diameter)
 Boom..... **2-140 mm x 1480 mm x 100 mm** 5.5" x 58.3" x 3.9"
 Arm..... **1-160 mm x 1825 mm x 110 mm** 6.3" x 71.9" x 4.3"
 Bucket..... **1-140 mm x 1285 mm x 100 mm** 5.5" x 50.6" x 3.9"



DRIVES AND BRAKES

Steering control..... Two lever with pedals
 Drive method..... Hydrostatic
 Maximum drawbar pull..... **290 kN 29570 kgf** 65,191 lbf
 Gradeability..... 70%, 35°
 Maximum travel speed (auto shift):
 High..... **5.5 km/h** 3.4 mph
 Mid..... **4.2 km/h** 2.8 mph
 Low..... **3.2 km/h** 2.0 mph
 Service brake..... Hydraulic lock
 Parking brake..... Mechanical disc brake



SWING SYSTEM

Driven by..... Hydraulic motor
 Swing reduction..... Planetary gear
 Swing circle lubrication..... Grease-bathed
 Service brake..... Hydraulic lock
 Holding brake/Swing lock..... Mechanical disc brake
 Swing speed..... 9.5 rpm
 Swing torque..... **11386 kg•m** 82,313 ft lbs



UNDERCARRIAGE

Centre frame..... X-frame
 Track frame..... Box-section
 Track type..... Sealed
 Track adjuster..... Hydraulic
 Number of shoes (each side)..... 48
 Number of carrier rollers (each side)..... 2
 Number of track rollers (each side)..... 8



COOLANT & LUBRICANT CAPACITY (REFILLING)

Fuel tank..... **605 ltr** 159.8 U.S. gal
 Radiator..... **37 ltr** 9.7 U.S. gal
 Engine..... **35 ltr** 9.2 U.S. gal
 Final drive, each side..... **9.0 ltr** 2.4 U.S. gal
 Swing drive..... **13.7 ltr** 3.6 U.S. gal
 Hydraulic tank..... **188 ltr** 49.7 U.S. gal
 Diesel Exhaust Fluid (DEF) tank..... **39 ltr** 10.3 U.S. gal



OPERATING WEIGHT (APPROXIMATE)

Operating weight includes **6500 mm** one-piece HD boom, **3200 mm** HD arm, rated capacity of lubricants, coolant, full fuel tank, operator, standard equipment, KGA dual lock quick hitch, and SAE heaped **1.80 m³** bucket.

Triple-Grouser Shoes	Operating Weight	Ground Pressure
600 mm	36,490 kg	0.69 kg/cm ²
700 mm	36,870 kg	0.60 kg/cm ²
850 mm	37,440 kg	0.50 kg/cm ²

Component Weights

Arm including bucket cylinder and linkage:
3200 mm HD arm assembly..... **1761 kg** 3,882 lb
 One piece HD boom including arm cylinder:
6500 mm boom assembly..... **3135 kg** 6,912 lb
 Boom cylinders x 2..... **259 kg** 571 lb
 Counterweight..... **6920 kg** 15,255 lb



DIMENSIONS

	Arm Length	3200 mm
A	Overall length	11145 mm
B	Length on ground (transport)	5935 mm
C	Overall height (to top of boom)*	3285 mm
D	Overall width	3190 mm
E	Overall height (to top of cab)*	3160 mm
F	Overall height (to top of handrail)*	3255 mm
G	Ground clearance, counterweight	1185 mm
H	Ground clearance, minimum	498 mm
I	Tail swing radius	3445 mm
J	Track length on ground	4030 mm
K	Track length	4955 mm
L	Track gauge	2590 mm
M	Width of crawler	3190 mm
N	Shoe width	600 mm
O	Grouser height	36 mm
P	Machine height to top of engine cover	3135 mm
Q	Machine upper width **	3145 mm
R	Distance, swing centre to rear end	3405 mm

* : Including grouser height ** : Including handrail

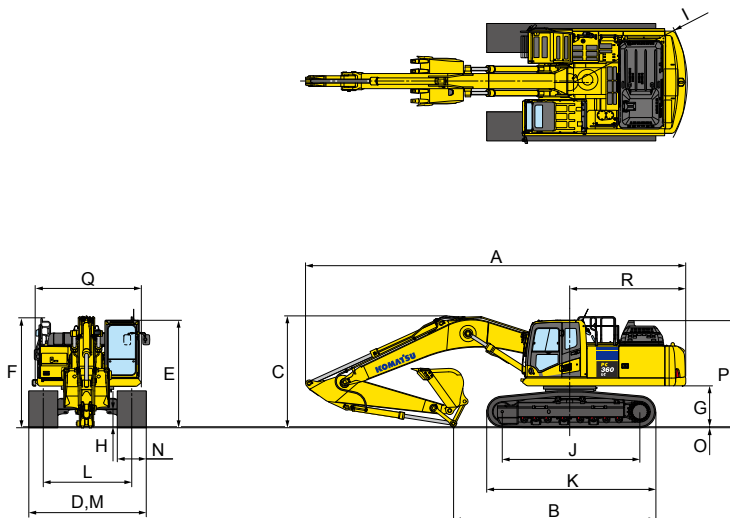

WORKING RANGE

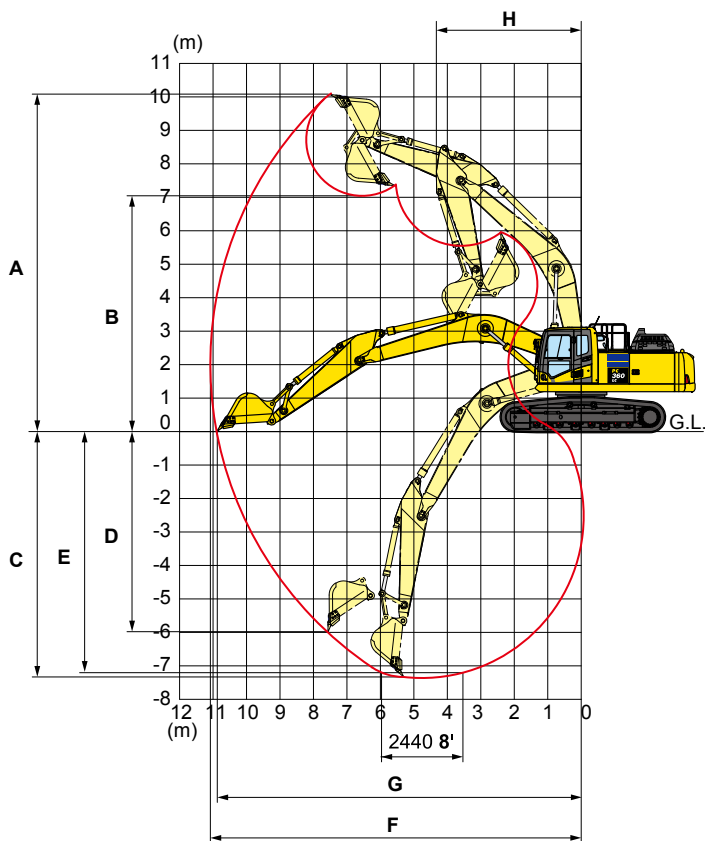

	Arm Length	3200 mm
A	Max. digging height	10210 mm
B	Max. dumping height	7110 mm
C	Max. digging depth	7380 mm
D	Max. vertical wall digging depth	6480 mm
E	Max. digging depth for 8' level bottom	7180 mm
F	Max. digging reach	11100 mm
G	Max. digging reach at ground level	10920 mm
H	Min. swing radius	4310 mm
SAE rating	Bucket digging force at power max.	200 kN 20400 kg
	Arm crowd force at power max.	165 kN 16800 kg
ISO rating	Bucket digging force at power max.	228 kN 23200 kg
	Arm crowd force at power max.	171 kN 17400 kg

LIFT CAPACITIES



LIFTING CAPACITY WITH LIFTING MODE

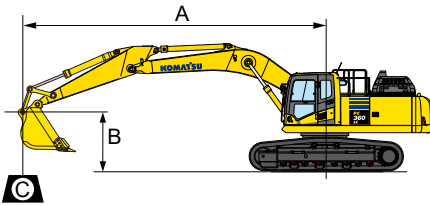

- A: Reach from swing centre
- B: Bucket hook height
- C: Lifting capacity
- Cf: Rating over front
- Cs: Rating over side
- ⊗: Rating at maximum reach

- Conditions :
- Boom length: 6500 mm
 - Arm length: 3200 mm
 - Shoes: 600 mm triple grouser
 - Bucket: 1014 kg

Unit: kg

A \ B	3.0 m		4.5 m		6.0 m		7.5 m		⊗ MAX	
	Cf	Cs	Cf	Cs	Cf	Cs	Cf	Cs	Cf	Cs
6.0 m							*7150	6850	*5200	5150
4.5 m					*9050	*9050	*7700	6600	*5350	4500
3.0 m			*14800	14100	*10500	9000	*8500	6300	*5650	4150
1.5 m			*16450	13050	*11800	8500	*9150	6000	*6200	4000
0.0 m	*8100	*8100	*17250	12500	*12400	8100	9400	5800	6650	4050
-1.5 m	*9550	*9550	*16750	12400	*12350	7950	9300	5650	7150	4350
-3.0 m	*17650	*17650	*15250	12550	*11500	7950	*8750	5650	*7550	5000
-4.5 m	*16250	*16250	*12600	*12600	*9550	8150			*7350	6450
-6.0 m									*6100	*6100

* Load is limited by hydraulic capacity rather than tipping. Ratings are based on SAE standard No. J1097. Rated loads do not exceed 87% of hydraulic lift capacity or 75% of tipping load.





STANDARD EQUIPMENT

- 3 speed travel with auto shift
- Alternator, 90 A, 24V
- AM/FM radio
- Arm, 3200 mm
- Auto idle
- Auto idle shut down
- Automatic air conditioner, large capacity
- Automatic engine warm-up system
- Auxiliary input (3.5 mm jack)
- Batteries, large capacity
- Battery isolation switch, lockable
- Boom, 6500 mm
- Boom and arm burst valve protection
- Bump rails
- Cab guards
 - Lower front window guard
 - Integrated top guard, OPG Level 1
 - Bolt on top guard, OPG Level 2
- Carrier rollers, (2 each side)
- Converter, (2) x 12 V
- Counterweight, 6920 kg
- Dry type air cleaner, double element
- Dual flow hammer piping
- Electric horn
- Emergency stops (3)
- EMMS monitoring system
- Engine, Komatsu SAA6D114E-6
- Engine overheat prevention system
- Fan guard structure
- Fuel system pre-filter 10 micron
- Grease sealed track chain
- High back air suspension seat, with heat
- High pressure in-line hydraulic filters
- Hydraulic track adjusters
- Hydraumind closed centre load sensing system
- KOMTRAX Level 5.0
- Large LCD colour monitor, high resolution
- Level indicator
- Lock lever
- Lock lever, auto lock
- Mirrors (LH, RH & sidewise)
- Operator identification system
- Overload alarm
- Power maximising system
- PPC hydraulic control system
- Proportional control handles
- Provision for tilt circuit, including valve
- Pump/engine room partition cover
- Quick hitch piping with safety switch and alarm
- Radiator and oil cooler dustproof net
- Rear reflectors
- Rearview monitoring system (1 camera)
- Revolving frame undercovers, heavy duty
- ROPS cab (ISO 12117-2) with vandal guard provisions
- Rotating beacon with guard
- Seat belt indicator
- Seat belt, retractable, 78 mm
- Secondary engine shutdown switch
- Side by side coolers
- Slip resistant foot plates
- Starter motor, 11 kW/24 V x 1
- Suction fan
- Thermal and fan guards
- Track frame swivel guard
- Track roller guards, full length
- Track rollers, 8 each side
- Track shoes, triple grouser, 600 mm
- Travel alarm
- Two boom mode setting
- Working lights
 - 1 x boom
 - 1 x RH
 - 3 x cab
 - 1 x counterweight
- Working mode selection system



OPTIONAL EQUIPMENT

- Autogrease system
- Battery isolation switch, dual pole, lockable
- Belly plates, 8 mm
- Cab guard
 - Full front guard, OPG Level 2
- Cab vandal guard set
- Canvas seat cover
- Fire extinguisher, 1.5 kg
- Fire extinguisher, 4.5 kg
- Fire extinguisher, 9 kg
- Fuel cap vandal guard
- Jump start receptacle
- Radio, multimedia system
- Radio, UHF
- Starter circuit isolation, lockable
- Track shoes, triple grouser, 700 mm
- Track shoes, triple grouser, 850 mm
- Turbo timer
- Window tinting



ATTACHMENT OPTIONS

- Bucket, general purpose, KGA 650 mm, 0.53 m³
- Bucket, general purpose, KGA 1300 mm, 1.35 m³
- Bucket, general purpose, KGA 1500 mm, 1.61 m³
- Bucket, general purpose, KGA 1700 mm, 1.80 m³
- Bucket, rock, direct pin, KGA 1600 mm, 1.66 m³
- Bucket, slope finishing, KGA 2200 mm, 2.20 m³
- Quick hitch, KGA, dual lock
- Ripper, KGA, single tyne

COMING SOON

KOMATSU JMHB360H-1 Hydraulic Breaker



Model Type		JMHB360H-1
Working weight	kg	2,571
Oil flow (min - max)	ℓ /min	175 - 250
Operating pressure (max)	MPa	155
Impact rate	bpm	320 - 560
Chisel diameter	mm	160
Variable frequencies	-	2 Auto
Acceptable back pressure	bar	25
Base machine (min - max)	Ton	27 - 40

For a complete list of available attachments, please contact your local Komatsu representative.

