

# KOMATSU

## PC3400-11M0



Photos may show equipments not available in your area

Hydraulic excavator

**Engine power**

1193 kW / 1600 HP @ 1800 rpm

**Operating weight**

Backhoe: 316800 - 321900 kg

Loading shovel: 317700 kg

**Bucket capacity**

Backhoe: 18.0 - 19.7 m<sup>3</sup>

Loading shovel: 19.0 m<sup>3</sup>

# Walk-around

PC3400-11M0 is developed with increased production and lower operating cost as its focus. The increased engine power output, more efficient hydraulic system and the new advanced total power control improves multifunction performance even with an increased bucket capacity.



#### Engine power

**1193 kW / 1600 HP @ 1800 rpm**

#### Operating weight

**Backhoe: 316800 - 321900 kg**

**Loading shovel: 317700 kg**

#### Bucket capacity

**Backhoe: 18.0 - 19.7 m<sup>3</sup>**

**Loading shovel: 19.0 m<sup>3</sup>**

# A new class of excavator to meet your needs

## Productivity features

- Increased engine power output with improved fuel efficiency
- Extended working range and increased bucket capacity
- Fast operating speed coupled with powerful digging force
- Electronic work equipment cylinder cushion for smooth and fast operation

## Ecology & economy features

- Improved hydraulic system with total power control, reducing fuel consumption by monitoring operator demand, machine condition and load
- Auto deceleration, auto low idle function to reduce fuel costs

## Operator comfort

- Spacious and low noise cab with high capacity dual air conditioner units
- Air suspension seat with console mounted armrests and seat belt caution
- Equipped with new 7-inch Liquid Crystal Display (LCD) monitor

## Maintenance features

- Centralized ground level drain and refill lubricants and coolant with service center
- Easy to access and centralized pre-operation check points
- Battery and starting motor disconnect switches with system operation indicator lamp to prevent controller power interruption related failures

## Safety & accessibility

- Spacious operator's cab with OPG level 2 protection (ISO 10262)
- Hydraulically operated 45° stairway for safe and easy access
- Additional emergency egress ladder at right side of machine
- Emergency engine stop switches strategically located in ground level, cabin and walkways
- Oil cooler access at machine platform for quick and easy maintenance
- Spacious walkways around main components for safe inspection and easy maintenance

## Reliability & durability

- Upsized machine structure with thicker plates for improved durability and reliability
- Optimized work equipment casting shape with reinforced the structure capable of high torsional and bending stress of mining operation
- Redesigned hydraulic cylinders with 5-piece sealing system to withstand the most abrasive application
- Upsized undercarriage with specific hardening of moving components increasing wear resistance while maintaining shock resistance
- Improved seals and hose construction to withstand a wide range of temperature and stress
- Simplified electric system with less mechanical components for improved reliability

## Information & Communication Technology (ICT)

- Standard equipment KomVision using a 7-camera system stitched to a bird's eye view of the work area
- Komtrax Plus for quick machine diagnostic and monitoring of machine health
- Wireless LAN download to get near real time data without stopping the machine

\*All comparison are with PC3000-6 unless otherwise specified.

# Productivity features

## Higher productivity

Lower hydraulic loss coupled with intelligent power matching.

**+ 31%**

## More powerful engine

940 kW → 1193 kW

**+ 27%**

VS. PC3000-6



## Larger bucket

Backhoe  
15.0 m<sup>3</sup> → 18.0 m<sup>3</sup>

**+ 20%**

Loading shovel  
16.0 m<sup>3</sup> → 19.0 m<sup>3</sup>

**+ 19%**

## Enhanced ICT features

- High resolution 7-inch LCD monitor
- 10-inch KomVision touch monitor
- Komtrax Plus
- Wireless LAN download

## Bigger, stronger, smarter and faster

PC3400-11M0 is a new class of hydraulic excavator that meet the constant evolving production demands.

### Backhoe bucket capacity (heaped)

General purpose	<b>18.0 m<sup>3</sup></b>	Allowed material density: 1.8 t/m <sup>3</sup>
	<b>19.7 m<sup>3</sup></b>	Allowed material density: 1.65 t/m <sup>3</sup>
Loading optimized	<b>18.0 m<sup>3</sup></b>	Allowed material density: 1.8 t/m <sup>3</sup>
	<b>19.0 m<sup>3</sup></b>	Allowed material density: 1.7 t/m <sup>3</sup>

### Loading shovel bucket capacity (heaped)

General purpose	<b>19.0 m<sup>3</sup></b>	Allowed material density: 1.8 t/m <sup>3</sup>
-----------------	---------------------------	--

## Increase productivity with bigger bucket

PC3400-11M0 offers large buckets with wide array of options to meet material and digging conditions.

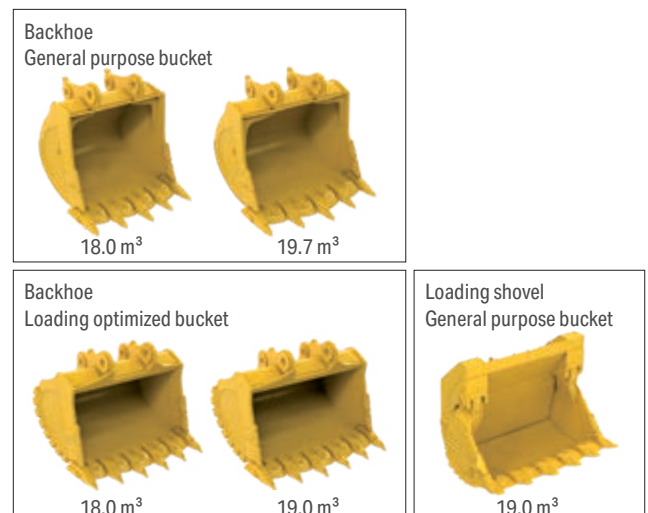

## Powerful digging operation

Digging force has become more powerful with the higher engine power output coupled with high capacity pump and efficient hydraulic system feeding the redesigned Komatsu hydraulic cylinders.

### Backhoe maximum arm crowd force (ISO 6015)

811 kN [82.7 t] → 872 kN [88.9 t] **+ 8%**

VS. PC3000-6

### Backhoe maximum bucket digging force (ISO 6015)

890 kN [90.8 t] → 1026 kN [104.6 t] **+ 15%**

VS. PC3000-6

### Loading shovel maximum arm crowd force (ISO 6015)

1100 kN [112.1 t] → 1274 kN [129.9 t] **+ 16%**

VS. PC3000-6

### Loading shovel maximum bucket digging force (ISO 6015)

1000 kN [101.9 t] → 1204 kN [122.8 t] **+ 20%**

VS. PC3000-6

## Electronic pump & bleed control system

The more efficient electronically controlled pump and main valves with quick response and low pressure loss significantly improve the work equipment speed to increase machine productivity.

## Electronic cushion function

Operation shocks are reduced for smoother and faster operation while preventing stress on the work equipment structure. The adjustable cylinder end of stroke cushion protects the machine and operator from stress and extends the life of the work equipment parts.

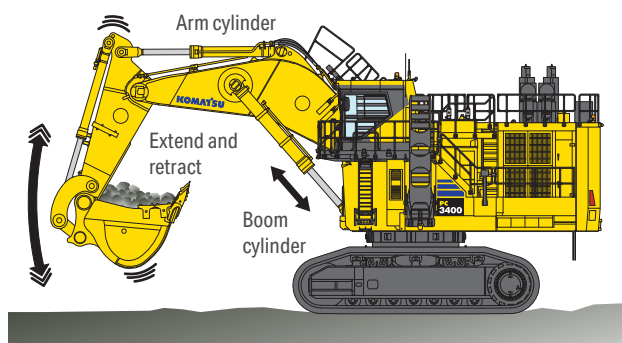

## Improved multifunction performance

The intelligent load sensing hydraulic system analyze operator input and load to improve multifunction performance with efficient power distribution in each pumps and smooth priority shift transition resulting to increased machine productivity.

## 24 hours continuous operation

Extend maintenance intervals and work non stop for 24 hours with a large size fuel tank.

## Long working range

The PC3400-11M0 work equipment range covers a wide area to work increasing the production to relocation ratio. This means less time and fuel is spent on relocation and preparation job while more time is spent on production.

## Work equipment reach

Backhoe: **17.1 m**

Loading shovel: **14.7 m**

Longest in its class



# Ecology & economy features

## High performance at low operating cost

- PC3400-11M0 is equipped with Komatsu SDA16V159-3 with high reliability, low emission and intelligent control system.
- This engine matches the on-demand power control system.
- Has fuel management system to extend engine oil maintenance intervals. (optional)
- Has a self-cleaning ELIMINATOR filter to extend oil filter maintenance intervals. (optional)

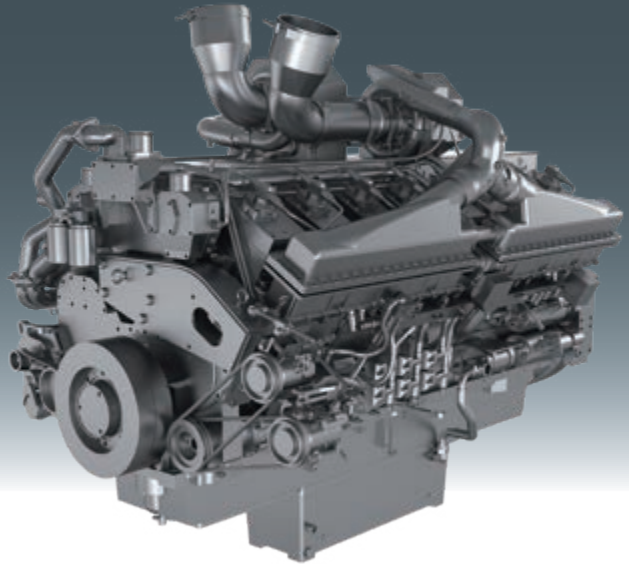

Komatsu SDA16V159-3 Tier 2 engine

## More powerful engine

940 kW → 1193 kW

**+ 27%**

VS. PC3000-6

## Auto deceleration system

The PC3400-11M0 is equipped with auto deceleration system that lowers engine speed to 1400 rpm after 4 seconds without operator input to work equipment controls. This lowers the fuel consumption during machine idle time.

## Auto idling system

Improves fuel savings further by lowering the engine speed down when the idle time reaches the operator pre-determined idle time.

## Efficient cooling system

Variable speed fan is monitored by a sensor and controlled depending on fluid temperature to use least energy required to maintain optimal working temperature. The high capacity radiator and oil coolers are designed to work even at harsh environments of up to 55 degrees celsius.



## Reduction of hydraulic pressure loss

The new main control valve, increase in piping diameter, and optimized piping route greatly contributes in the reduction of hydraulic loss. This efficient hydraulic system is one of the keys to improve working speed, digging power and low fuel consumption.

## Boom recirculation valve

Speeds up operation and reduce fuel consumption by letting gravity help with the work. Returning oil from boom cylinder bottom side is driven by work equipment weight into the rod side of cylinder, reducing the load on the engine.

## ECO guidance record

The Ecology Guidance records show the operation records and fuel consumption history to assist the operators improve operation efficiency by reducing the fuel consumption and idle time. Fuel consumption history is displayed both in days and hours.

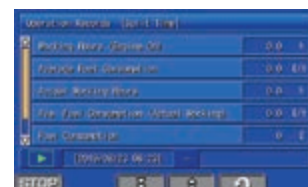

Operation record



Fuel consumption history

### Fuel saving total power management technology

PC3400-11M0 is an intelligent machine that detects the operator input and work equipment load then matches the optimal pump output flow for fast execution while the on-demand power control system assures the minimal required power output is supplied to burn the least fuel possible. This fuel saving technology is achieved by the network of sensors, load sensing hydraulic system and a smart control logic developed with decades worth of accumulated research, design and field experience.

#### Fuel efficiency

Increased by **22%**

VS. PC3000-6

#### Electronic main valves

Electronically controlled main valves improve quick response and multi function performance to increase machine productivity.



#### Operator and sensor input

Operator input and machine parameters are constantly monitored and used as factors for managing pump flow, cooling fan speed and engine output.



#### Total power management

Inter-controller communication to assess input factors and perform total power control.



#### Pump flow rate

Pump flow is adjusted responding to the minimum optimal requirement of the operator and load demand reducing losses of excess supply.

#### Fan rotation speed

Variable speed fan helps maintain coolant and hydraulic oil in optimal working temperature with minimal power used.

#### Engine power output

Fuel savings is improved as engine matches the on-demand power requirement to drive the pump and cooling fans.



# Reliability & durability

## Durable main upper frame

Machine upper main frame is built with thick plates and strategically reinforced on load concentrated parts.



## Travel motor cover (optional)

Sturdy guards protect the travel motor and related hydraulic piping from thrust of large rocks. The assembly comes with an inspection window for easy inspection and maintenance.

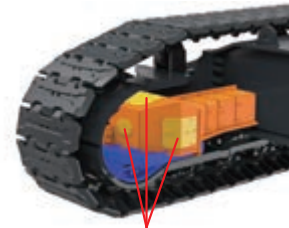

Inspection window

## Tough and durable undercarriage frame

The PC3400-11M0 undercarriage structure is reinforced for improved durability and offers protection to all piping and moving parts.



## All terrain rollers and shoes

Rollers and shoes are precision hardened to withstand even the most abrasive working conditions and at the same time made flexible to maintain load distribution adapting to any uneven mining ground conditions.

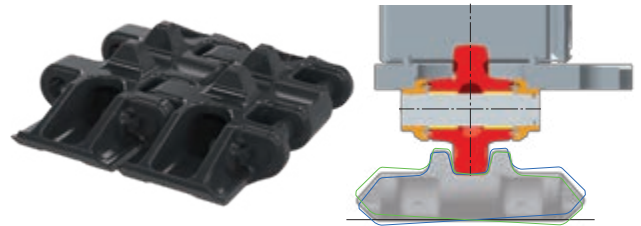

## Optimized shape for casting parts

Casting parts shape have been redesigned to increase structure durability against load impact and torsion.



## Large diameter grease lubricated rollers

Large diameter track and carrier rollers are hardened to minimize wear and resist impact. The grease lubrication ensures smooth motion to lessen drag and improve travel performance.

## Improved hose routing

Optimized hose routing and positioning lowers hydraulic loss and extends the hose life by increasing the hose curve radius and decreasing hose curve deformation and stress.

## Durable swing circle triple roller bearings

The swing circle is equipped with triple roller bearings with improved load distribution to minimize stress, reducing wear rate and extending component life.

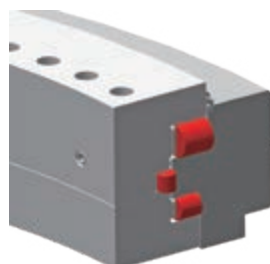



### 5-piece dust sealing system

Additional scraper and dust seal totals to a 5-piece sealing system, prevents entry of dust to the hydraulic system through the work equipment cylinders. This extends the hydraulic oil and cylinder maintenance intervals.

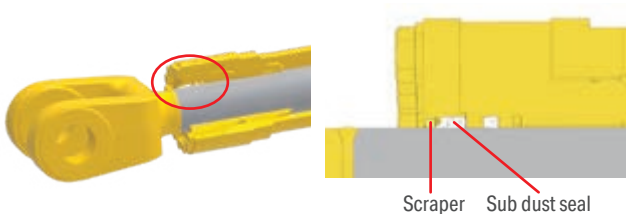

### Excellent reliability flexible pin seals

Pin seals are made flexible to maintain high sealing performance and avoid breaking even when the sealed parts are moving relative to each other. The seal maintains optimal grease amount between the pins and bushings and protects them from dirt and dust entry to maintain smooth joint motion and extending pin and bushing life.

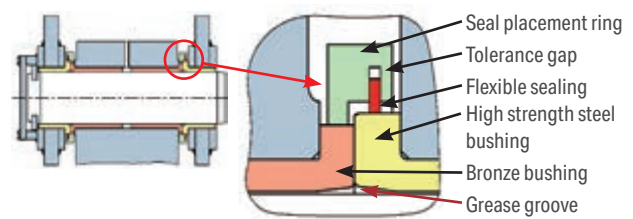

### Heat resistant seal and hose

Hoses and seals are designed to meet the proven quality of the Komatsu engineering standard. The o-ring seals and packing seal of the hydraulic system are designed with high heat resistance for a worry-free operation even in the hottest regions.

### Simplified electrical system

A simplified electrical system eliminates mechanical relays and replacing them with controllers for a more reliable system. Simplified electrical systems are also easy to maintain and troubleshoot and has low power loss and requirements.



# Safety & accessibility

## Operator cab specially designed for mining

Operator cab provides a comfortable working environment. Sturdy cab of solid construction, with top guard compliant to OPG level 2 (ISO 10262).



## Seat belt caution

Displayed on the monitor to alert the operator whenever the seat belt is not fastened.



## Safety lock lever

Safety lock lever prevents accidental work equipment movement when placed in lock position. Control lever is also automatically locked when ladder and service arm are in lowered position.

## Auto lever lock function

This safety feature prevents undesired work equipment movement when the hydraulic lock lever is released while the control levers are not in neutral position. The hydraulic lock lever auto lock message is displayed in the monitor screen.

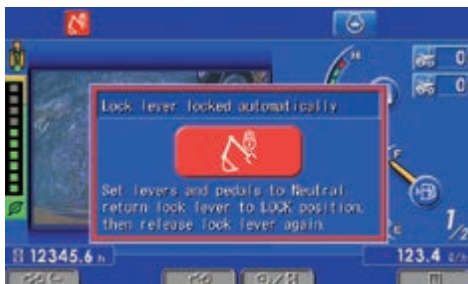

## Emergency egress

Two emergency egress routes to quick release ladders located around the machine are easily accessible through wide walkways.



Cab side quick release ladder

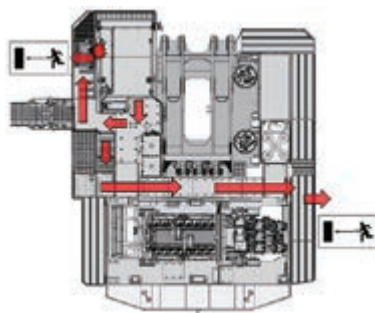

Right side quick release ladder

## Emergency engine stop switch

Highly visible easy operation emergency engine stop switches are strategically located around the machine. The switches have a reset feature to prevent accidental engine restart.

Cab console



Pump room door

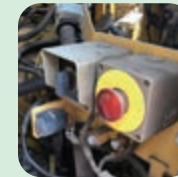

Engine room rear

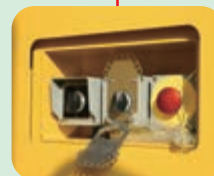

Engine room front

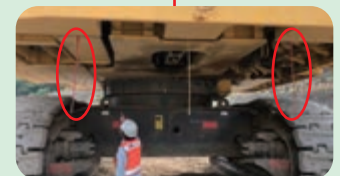

Under the machine (2 units)

## Partition wall

The hot components of the engine room are isolated from the pump room and main valves by partition walls.

## 45° access ladder and stairs

A hydraulically operated 45° access ladder is equipped as standard with anti slip steps and handrails. The ladder movement can be activated both from the platform and from the ground. Stairs from platform to cab is also at 45° angle.



## Boom handrail and access ladder

Easy access to the boom for quick inspection or thorough maintenance with standard equipment safety handrails and access ladder.



Access to boom catwalk

Boom catwalk with handrails

## Easy access to oil coolers

Oil cooler inspection and maintenance is easier and faster due to accessibility to both sides on the machine upper structure platform. This eliminates the need for an external elevated platform equipment.



## Boom walkway tie-off points

As an additional safety feature, tie-off points are in the boom walkway to ensure servicemen safety. EN 795, EN 50308, OSHA 1926.502 compliant.

## Access lights

Bright LED lamp access lights are strategically located all around the machine for safe operator access and nighttime inspections. Access light switch is in the access ladder to climb safely and at operator console when descending.

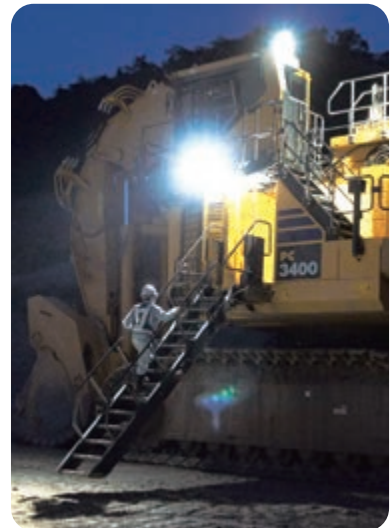

## Spacious walkways to major components

The wide walkways all around the machine provides stable footing, safe working position, good visibility and easy access to components for safer, more efficient and faster maintenance jobs to lessen machine downtime.

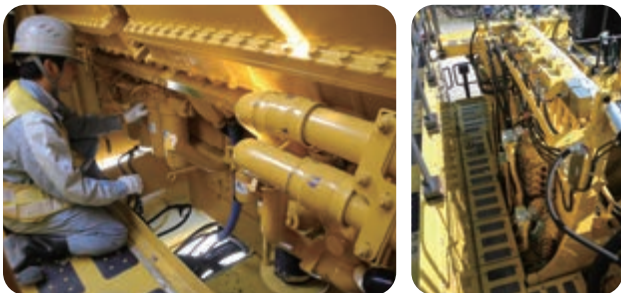

## Slip resistant walkways

Walkways are placed with slip resistant plates and grated floors to ensure good footing even when wet with rain and with dust accumulation.



## All around handrails with foot guard

Tall and sturdy handrails are located all around the machine which includes 100 mm high foot guard to provide protection and support during inspection and maintenance.

## Cab front platform

Cab front glass and wiper maintenance are made easier with cab front platform with railings.

# Operator comfort

## Comfortable working experience

The PC3400-11M0 has a spacious operator's cab offering very good visibility and maximum comfort even at extreme climate and harsh operating conditions.



## Comfortable air suspension seat

The seat with air suspension minimizes the vibration experienced by the operator are adjustable to a wide range of operator physique. The control consoles are integrated to the seat suspension for improved comfort and reduced fatigue.



## Ergonomic control levers

Ergonomic and low effort electric control levers reduce stress on the hands during long operation.



## Low vibration with cab damper mounting

Multiple viscous dampers are installed to lessen vibration and noise transmission to the operators' cab.

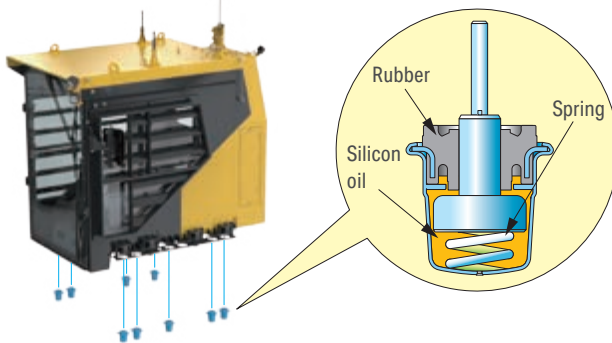

## Operator trainer's seat

A trainer's seat is located diagonally behind the operator offering good vision to both the working environment and the operator actions.

## Dual wiper cleaning

The cab front glass has dual wipers with window washer for maximum glass surface cleaning and assure good visibility in both rainy and dusty weather.

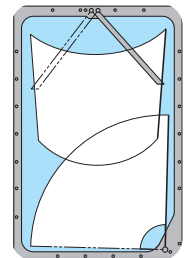

## Powerful dual air conditioner (A/C) units

The PC3400-11M0 operator's cab is equipped with dual high capacity automatic air conditioning system providing operator comfort even in extreme climates.

## Powerful working lights

Durable and bright LED lamp working lights are strategically located to provide all around optimal work environment visibility during nighttime operation.

## Low noise cab

The large operator's cab is pressurized to prevent dust entry and insulated to reduce dynamic noise level for improved operator awareness of the work environment.

## Dynamic noise level

Inside the cab **70.1dB(A)**

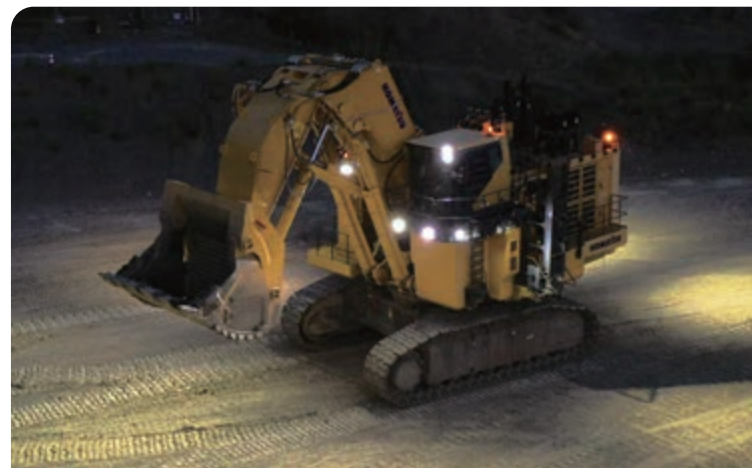

### Large high-resolution monitor

Display option 1



Display option 2

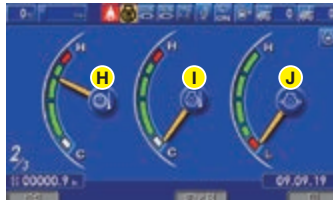

Display option 3



#### Indicators

- |                                      |  |                                      |
|--------------------------------------|--|--------------------------------------|
| <b>A</b> Pilot control cut out       | <b>K</b> Central lubrication grease level      | <b>S</b> Fan reverse rotation        |
| <b>B</b> Service meter / time        | <b>L</b> Swing circle lubrication grease level | <b>T</b> Central lubrication ON      |
| <b>C</b> Service meter / time toggle | <b>M</b> Voltage gauge                         | <b>U</b> Swing circle lubrication ON |
| <b>D</b> Date                        | <b>N</b> Coolant temp low                      | <b>V</b> Service arm down position   |
| <b>E</b> Coolant temperature         | <b>O</b> Auto-deceleration                     | <b>W</b> Ladder down position        |
| <b>F</b> Hydraulic oil temperature   | <b>P</b> Ambient temperature                   | <b>X</b> Wiper ON                    |
| <b>G</b> Fuel level                  | <b>Q</b> Engine speed                          | <b>Y</b> Swing lock                  |
| <b>H</b> PTO oil temperature         | <b>R</b> Seat belt caution                     | <b>Z</b> Truck counters              |
| <b>I</b> Engine oil temperature      |  |                                      |
| <b>J</b> Engine oil pressure         |  |                                      |

#### Operation switches

- |                            |                        |                        |
|----------------------------|------------------------|------------------------|
| <b>1</b> Function switches | <b>3</b> Wiper         | <b>5</b> Buzzer cancel |
| <b>2</b> Auto-decelerator  | <b>4</b> Window washer |                        |

### Operator's menu

Pressing the F6 key on the main screen displays the user menu screen. The operation items, information and selectable options are grouped based on functionality and easy-to-understand icons.



Pressing F1 and F2 switches between operation related screens.

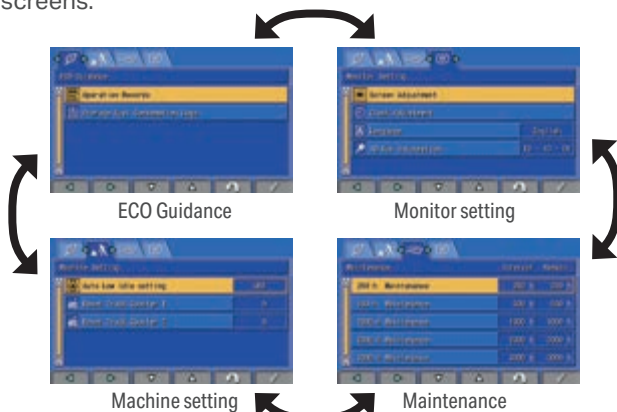

### Dashboard buttons

Backlit operation control buttons, system and power ports with easy to understand icons are systematically arranged in the dashboard.

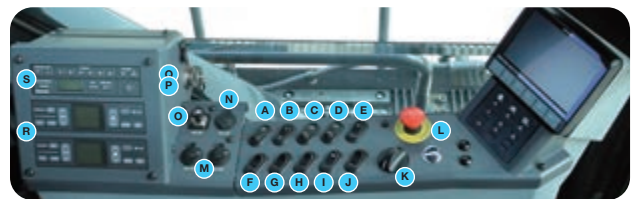

- |  |                                      |
|--|--------------------------------------|
| <b>A</b> Swing lock switch                 | <b>K</b> Fuel control dial           |
| <b>B</b> Service arm switch                | <b>L</b> Emergency stop switch       |
| <b>C</b> Swing circle lubrication switch   | <b>M</b> 2 x 12 V sockets            |
| <b>D</b> Work equipment lubrication switch | <b>N</b> 24 V socket                 |
| <b>E</b> Rotary beacon light switch        | <b>O</b> 24 V socket / Cigar lighter |
| <b>F</b> Step light switch                 | <b>P</b> Komtrax Plus terminal       |
| <b>G</b> Work light switch                 | <b>Q</b> 3.5 mm AUX terminal         |
| <b>H</b> Mirror heater switch              | <b>R</b> 2 x A/C control unit        |
| <b>I</b> Cab room lamp switch              | <b>S</b> Radio                       |
| <b>J</b> Truck counter 2 switch            |                                      |

### 12 V and 24 V power socket

The operator cab console comes with 2 sockets each of 12 V and 24 V power sockets with one 24 V socket used as cigar lighter.

### Radio with 3.5 mm AUX port

An AM/FM radio with 3.5 mm auxiliary port comes as standard equipment.

# ICT & Komtrax



## All around monitoring system

KomVision is included as standard equipment consisting of a 7-camera system stitched into a bird's eye view image eliminating blind spots. The bird's eye view image also show reference lines making it easier for operator to evaluate the distance of objects around the machine.

- Red – Swing radius
- Yellow – 2 m from swing radius
- Black – 12 m from swing radius



## Dedicated 10-inch touch screen

The dedicated large high-resolution touch screen is also used to switch and select individual views from each of the 7 cameras.

## Remote monitoring and fleet management

Enhanced Komtrax Plus enables near real time monitoring of the fleet via satellite and wireless LAN. Critical production and maintenance related information is easily accessible to improve operator productivity with operation records and machine performance with the trend data.

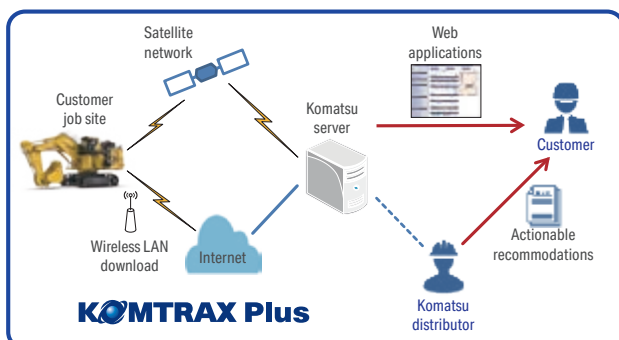

## Data log feature

The enhanced Komtrax Plus has a new data log feature with a per second record of sensor readings which is useful for both diagnostics and productivity analysis.

## Enhanced Komtrax Plus wireless download

Fast download of the complete Komtrax Plus data without stopping the machine through wireless LAN download application in your laptop. This feature comes as standard equipment to the machine.



# Maintenance features

## Centralized daily inspection points

Easy access to all pre-operation inspection points accessible from the machine walkway for a quick daily inspection execution.

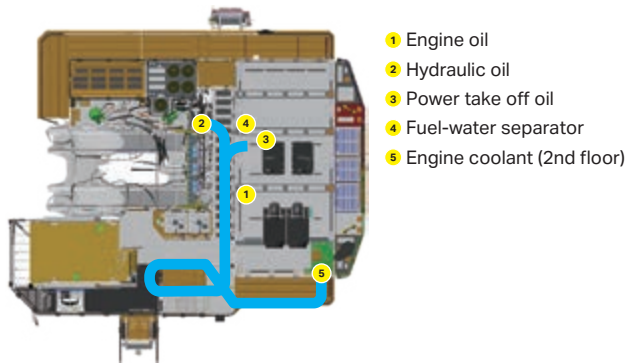

- 1 Engine oil
- 2 Hydraulic oil
- 3 Power take off oil
- 4 Fuel-water separator
- 5 Engine coolant (2nd floor)

## Ground accessible centralized service arm

A hydraulically operated service arm comes as standard equipment to quickly drain and fill lubricants, oils and coolant from the ground.



- Engine oil
- Engine coolant
- Oil reserve tank (optional)
- Swing circle lubrication
- Central lubrication
- Hydraulic oil
- PTO oil
- Fuel

## Automatic greasing system

Two units of auto greasing system are installed to ensure constant optimal lubrication to machine moving parts needing different types of grease. Refill line strainer and in-line grease filter prevents grease contamination, and in-line sensors monitor that the system is at optimal condition.

## Long life filters with clog detection sensors

Filter maintenance intervals are extended and synchronized for one-time maintenance. Filter saturation is monitored by sensors to detect clogs as soon as they happen.



## Easy to replace tooth and lip shroud

Komatsu ground engaging tools are mounted with durable and hammerless installation lock system making the replacement faster and safer.

## Battery disconnect and starter cut switches

Prevents unwanted engine cranking when conducting maintenance jobs. Comes with system operation indicator lamp that helps avoid power interruption when controller is still in operation.



## Maintenance lights

Low power consumption and bright LED lamp are strategically located in the machine service points for nighttime work illumination.

## Fan reverse function

Dust accumulated in the radiator and oil coolers are easily blown off without the need for external equipment by reversing the fan rotation.



## Easy troubleshooting and diagnostics

Failure history record and customizable real time machine monitoring provides an in depth look to the machine condition for faster and easier diagnostics.

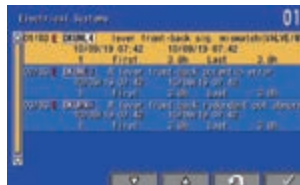

Machine abnormality records

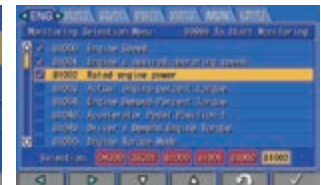

Real time monitoring

## Maintenance records

Shows a countdown to upcoming maintenance activities and improve in maintenance planning.



# Komatsu total support



## Komatsu total support

Komatsu Distributor is ready to provide variety of support before and after procuring machine to keep customers machine available and minimize operation cost.

## Fleet recommendation

Komatsu Distributor can study customer job site and provide the most optimum fleet recommendation with detailed information to meet all of your application needs when you are considering to buy new machines or to replace the existing ones from Komatsu.

## Product support

Komatsu Distributor secure the quality of machine by offering quality repair and maintenance services to the customer using Komatsu developed programs.

- Preventive Maintenance (PM) Clinic
- Komatsu Oil and Wear Analysis (KOWA)
- Undercarriage inspection service, etc.

## Genuine parts and genuine oil

Komatsu Distributor will promptly and smoothly offer genuine parts and genuine oil guaranteed quality to various jobsites. Genuine oil is developed by Komatsu so that it is best matched for our Komatsu engines and hydraulic components. It maximizes engine and hydraulic components performance and prolong life.

## Service contract

Komatsu Distributor offers several service package of repair and maintenance for a contracted period with optimum cost. Customer can be "worry-free" by trusting Komatsu Distributor skilled service.

## Extended warranty

Extended warranty with several options available. Komatsu guarantee skilled repair with genuine parts and protection from unexpected expenses.

## Operator training

Komatsu Distributor can provide excellent operator training which enables them to operate machine safely & efficiently and to maintain machine properly.



# Specifications

## Engine

Model	Komatsu SDA16V159-3
Type	4-cycle, water-cooled, direct injection
Aspiration	Turbocharged, aftercooled
Engine power	
at rated engine speed	1800 rpm
SAE J1995	1193 kW/1600 HP
SAE J1349	1186 kW/1590 HP
No. of cylinders	16
Bore × stroke	159 × 159 mm
Displacement	50.51 l
Radiator cooling fan drive	Hydraulic
Oil cooler fan drive	Hydraulic
Governor	All-speed, electronic
Engine emissions	EPA Tier 2 emissions certified
Fuel	Up to 20% blended paraffine fuel can be used. Please consult your Komatsu distributor for detail.

## Hydraulic system

Type	Electronic pump & bleed control system
Main pump	
Type	Variable displacement piston pumps
Total flow rate for attachment	2973 l/min
Fan pump flow	
Radiator fan	295 l/min
Oil cooler fan	259 l/min
Hydraulic motors	
Travel	2 × axial piston motors with parking brake
Swing	2 × axial piston motors with swing holding brake
Relief valve setting	
Implement	32.9 MPa/335 kgf/cm <sup>2</sup>
Travel circuit	34.3 MPa/350 kgf/cm <sup>2</sup>
Swing circuit	29.9 MPa/305 kgf/cm <sup>2</sup>
Pilot circuit	4.5 MPa/46 kgf/cm <sup>2</sup>
Hydraulic cylinders	(Number of cylinders - bore × stroke)
Backhoe	
Boom	2 - 330 mm × 2770 mm
Arm	2 - 280 mm × 1975 mm
Bucket	2 - 225 mm × 2500 mm
Loading shovel	
Boom	2 - 330 mm × 2295 mm
Arm	2 - 240 mm × 2380 mm
Bucket	2 - 260 mm × 2350 mm
Bottom dump	2 - 210 mm × 665 mm

## Drives and brakes

Steering control	Two pedals
Gradeability	53%, 28°
Maximum travel speed	2.3 km/h
Parking brake	Oil disc brake

## Swing system

Swing gear	2 × planetary gears
Swing circle lubrication	Grease type
Swing holding brakes	Oil disc brakes
Swing speed	4.0 rpm

## Undercarriage

Track adjuster	Hydraulic
No. of shoes (each side)	48
No. of carrier rollers (each side)	3
No. of track rollers (each side)	7

## Service refill capacities

Fuel tank	5300 l
Radiator	393 l
Engine	204 l
Reserve tank	561 l
Final drive (each side)	84 l
Swing gear box (each side)	55 l
Hydraulic tank	2200 l
Power Take Off (PTO)	87 l
Swing lubrication grease	165 l
Central lubrication grease	165 l

## Operating weight (appr.) - Backhoe

Shoes	Operating weight	Ground pressure
900 mm	316800 kg	2.52 kgf/cm <sup>2</sup>
1200 mm	321900 kg	1.90 kgf/cm <sup>2</sup>

Operating weight including 9000 mm boom and 4150 mm arm, heaped 18.0 m<sup>3</sup> general purpose backhoe bucket, lubricant, coolant, full fuel tank and standard equipment.

## Operating weight (appr.) - Loading shovel

Shoes	Operating weight	Ground pressure
900 mm	317700 kg	2.53 kgf/cm <sup>2</sup>

Operating weight including 6850 mm boom and 4700 mm arm, heaped 19.0 m<sup>3</sup> bottom dump bucket, lubricant, coolant, full fuel tank and standard equipment.

# Backhoe

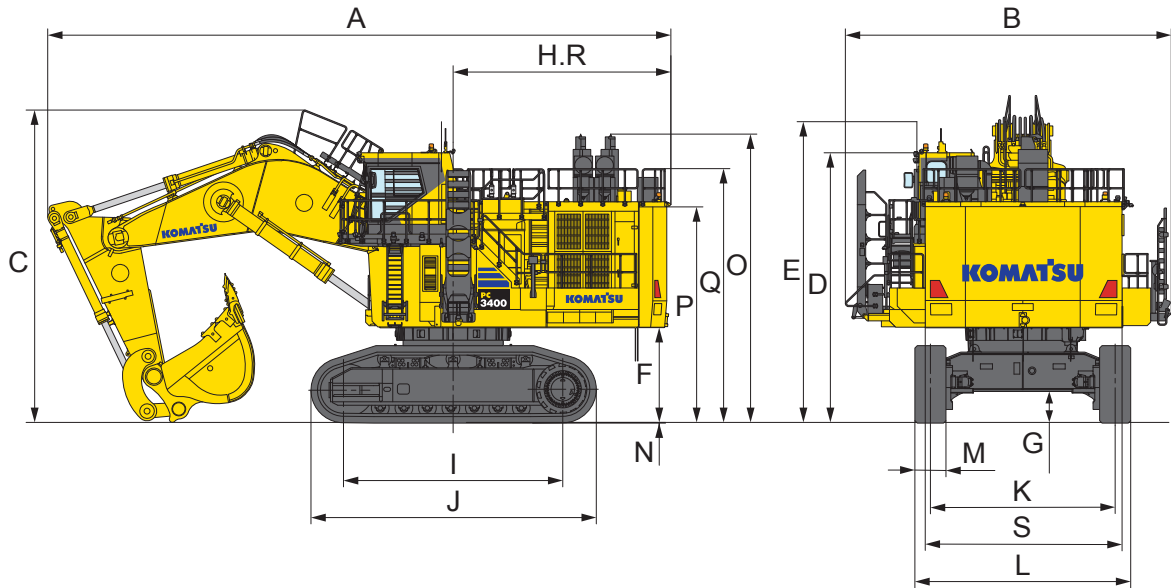

## Dimensions

Boom length	9000 mm
Arm length	4150 mm
A Overall length	18080 mm
B Overall width	9440 mm
C Overall height (to top of boom)	9040 mm
D Overall height (to top of cab)	7810 mm
E Overall height (to top of wireless LAN antenna)	8710 mm
F Ground clearance, counterweight	2745 mm
G Ground clearance (minimum)	895 mm
H Tail swing radius	6530 mm
I Track length on ground	6350 mm
J Track length	8285 mm
K Track gauge	5350 mm
L Width of crawler	6250 mm
M Shoe width	900 mm
N Grouser height	20 mm
O Height to top of exhaust pipe	8350 mm
P Machine cab height	6250 mm
Q Height to rear handrail	7350 mm
R Distance, swing center to rear end	6305 mm
S Counterweight width	5700 mm

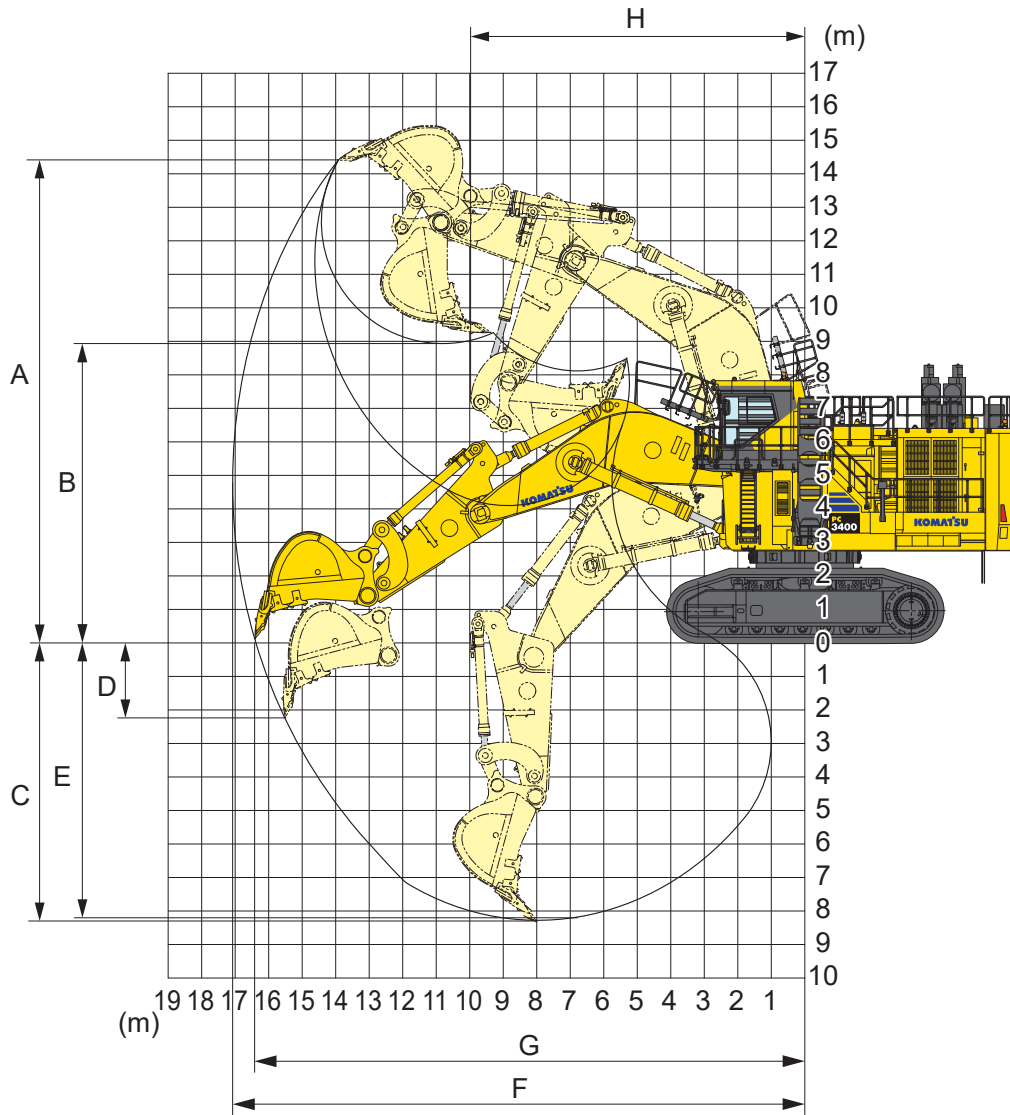

**Working range**

Boom length	9000 mm
Arm length	4150 mm
A Max. digging height	14400 mm
B Max. dumping height	8920 mm
C Max. digging depth	8300 mm
D Max. vertical wall digging depth	2300 mm
E Max. digging depth of cut for 2440 mm level	8200 mm
F Max. digging reach	17075 mm
G Max. digging reach at ground level	16365 mm
H Min. swing radius	9990 mm
Bucket digging force (SAE J 1179)	924 kN (94200 kgf)
Arm crowd force (SAE J 1179)	843 kN (85900 kgf)
Bucket digging force (ISO 6015)	1026 kN (104600 kgf)
Arm crowd force (ISO 6015)	872 kN (88900 kgf)

# Loading shovel

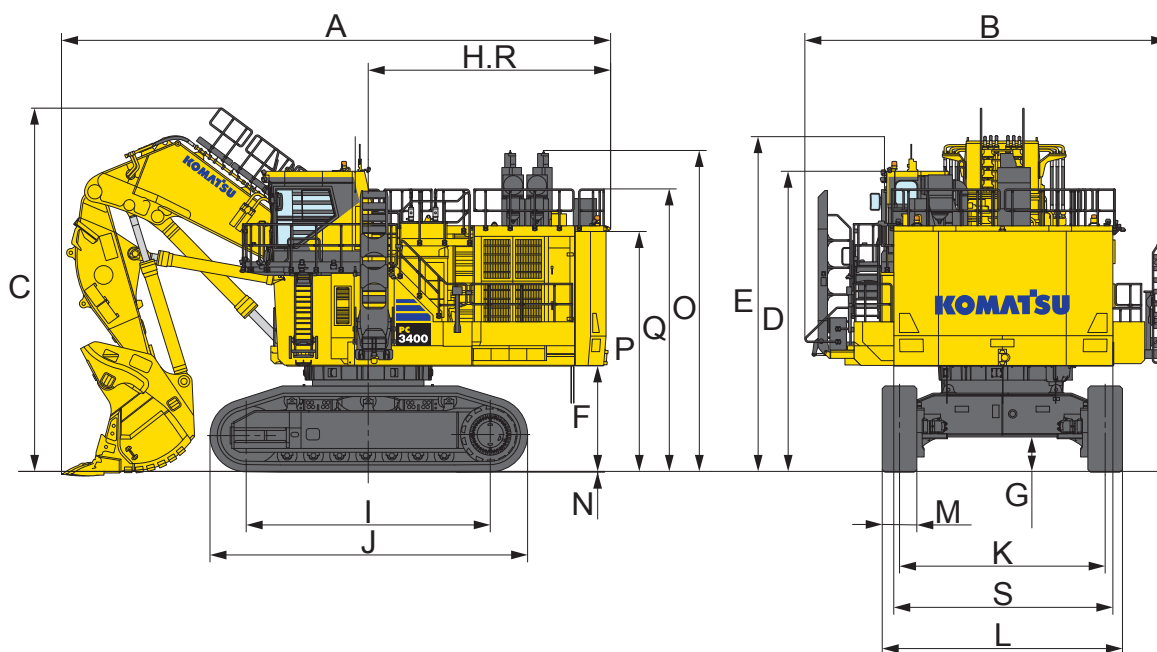

## Dimensions

Boom length	6850 mm
Arm length	4700 mm
A Overall length	14265 mm
B Overall width	9440 mm
C Overall height (to top of boom)	9445 mm
D Overall height (to top of cab)	7810 mm
E Overall height (to top of wireless LAN antenna)	8710 mm
F Ground clearance, counterweight	2745 mm
G Ground clearance (minimum)	895 mm
H Tail swing radius	6530 mm
I Track length on ground	6350 mm
J Track length	8285 mm
K Track gauge	5350 mm
L Width of crawler	6250 mm
M Shoe width	900 mm
N Grouser height	20 mm
O Height to top of exhaust pipe	8350 mm
P Machine cab height	6250 mm
Q Height to rear handrail	7350 mm
R Distance, swing center to rear end	6305 mm
S Counterweight width	5700 mm

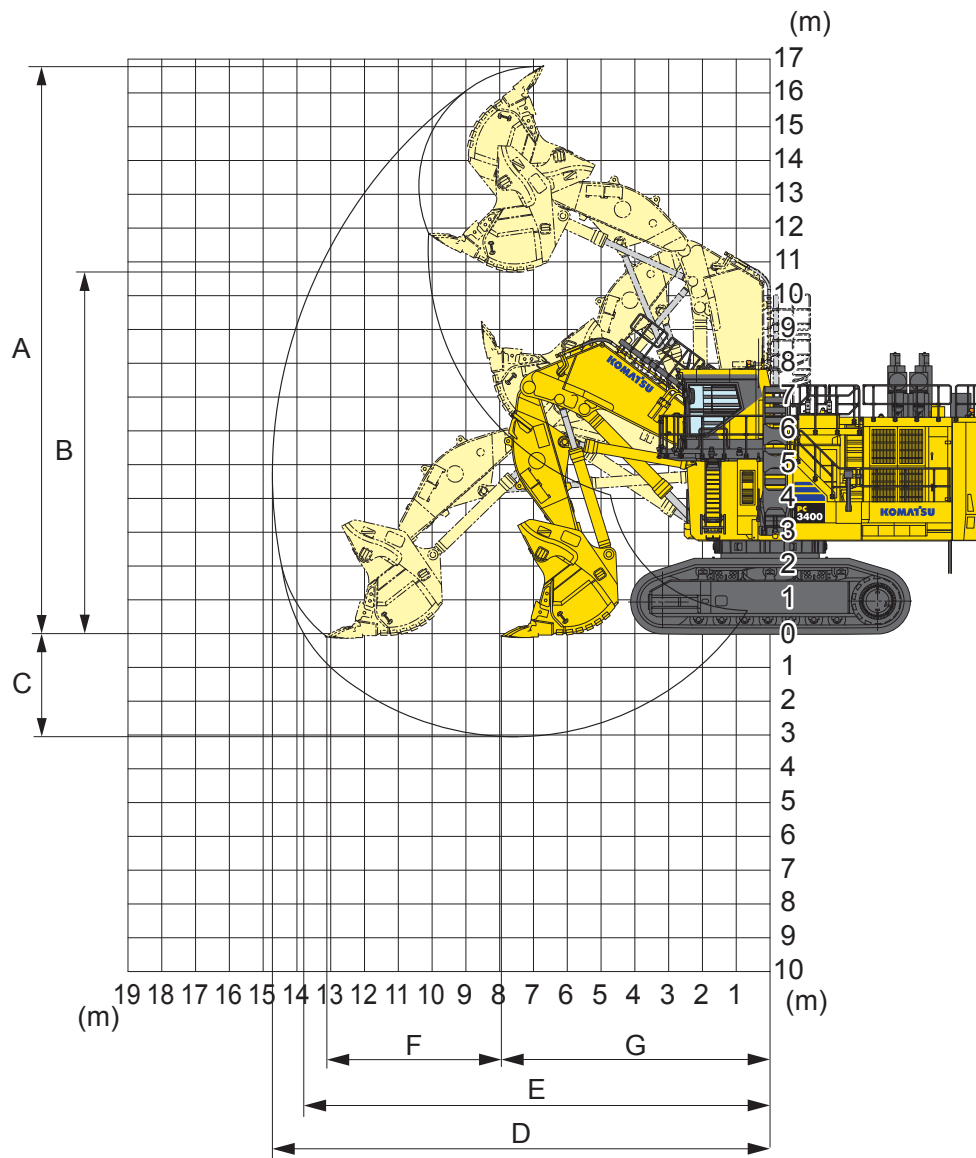

## Working range

Type of bucket	Bottom dump
Capacity - heaped	19.0 m <sup>3</sup>
A Max. cutting height	16800 mm
B Max. dumping height	10780 mm
C Max. digging depth	3040 mm
D Max. digging reach	14740 mm
E Max. digging reach at ground level	13845 mm
F Level crowding distance	5200 mm
G Min. crowd distance	7955 mm
Bucket digging force	1204 kN (122800 kgf)
Arm crowd force	1274 kN (129900 kgf)

# Standard and optional equipment

## Engine and related items

Komatsu SDA16V159-3 engine	●
Dry type air cleaner, double element	●
Automatic engine warm-up system	●
Automatic pre-lubrication pump	●
Electric priming pump for fuel	●
Fuel pre-filters with water separators	●
Two variable speed, reversible radiator fans with fan guard and speed sensor, hydraulic drive	●
Extra poor fuel filter package	○

## Hydraulic system

Electric end of stroke cushioning system for boom and arm	●
Gear pump for Power Take Off (PTO) lubrication	●
High-capacity low noise oil cooler with two variable speed, reversible fans with fan guard and speed sensor, hydraulic drive	●
Hydraulic oil transfer pump	●
One axial piston motor per track for travel with travel brake valve	●
Optimized electrical valve control for smooth and efficient compound movement	●
Three electronic control valves for work equipment, swing and travel	●
Two axial motors for swing system with two stage relief valves	●

## Drive system

Automatic travel parking brake	●
Planetary travel gear with axial piston motor	●

## Undercarriage

900 mm double grouser shoes	●
Heavy-duty undercarriage	●
Hydraulic idler cushion with 2-stage accumulators	●
1200 mm double grouser shoes	○
Travel motor and piping full guard	○
Travel motor guard	○

## Cabin

Automatic air conditioners (twin)	●
Built-in top guard conforming to OPG level 2 (ISO 10262)	●
Electric control levers for work equipment and swing	●
Electric control pedals for travel	●
Electric pedal for dynamic swing brake	●
Impact resistant large front windshield (19 mm)	●
KomVision, all around monitoring system	●
Large damper mounted and pressurized mining shovel cab with lockable door, large twin wipers and washers, floor mats, cigarette lighter, ashtray, 12 V/24 V power supplies (2 each), and cup holders	●
Lock lever	●
Seat belt, 78 mm	●
Seat, heated, high back, fully adjustable air suspension with retractable seat belt	●
Sun visor (front and side)	●
Trainer's seat with seatbelt	●
Walkway in front cab	●

## Electrical system

AM/FM radio with auxiliary input (3.5 mm jack)	●
Auto decelerator and auto idling system	●
Battery disconnect and starting motor disconnect with controller indicator lamp	●
Emergency engine stop switches (2 × ground, engine room, pump room, central walkway, cab)	●
Ladder operation alarm	●
Lighting switches instrument panel	●
Lock lever auto-lock	●
Maintenance free battery	○

## Guards and covers

Heat guard for high temperature exhaust line	●
Pump/engine room partition cover	●
Swing circle gear cover with inspection window	●
Cab front full guard OPG level 2 (ISO 10262)	○
Rock protection cab glass	○

## Other

+55 °C specification	●
Enhanced Komtrax Plus with wireless LAN (vehicle health monitoring system)	●
Fire extinguisher inside cab	●
Fuel cut-off lever	●
Fully automatic greasing system for work equipment and swing circle, 2 × 165 l	●
Fully hydraulic operated 45° access ladder and stairway to cab	●
PM tune-up service connection	●
Provision for modular mining system installation	●
Quick release emergency egress ladder on cab side and right side	●
Satellite communication system for enhanced Komtrax Plus (Iridium)	●
Service center system, fuel quick change system (grease, oils, fuel, coolant)	●
Cold weather package down to -40 °C	○
Oil management system (Centinel, Reserve and Eliminator systems)	○
Satellite communication system for enhanced Komtrax Plus (Orbcomm)	○

## Lighting

6 LEDs for access light	●
8 LEDs for maintenance light	●
12 LEDs for working light	●
Additional amber beacon lights located at oil cooler and counterweight	○

## Backhoe attachment

18.0 m <sup>3</sup> general purpose bucket	●
4150 mm arm	●
9000 mm boom	●
19.7 m <sup>3</sup> general purpose bucket	○
18.0 m <sup>3</sup> / 19.0 m <sup>3</sup> loading optimized bucket	○
Bucket cylinder sliding guard	○

## Loading shovel attachment

19.0 m <sup>3</sup> general purpose bucket	●
4700 mm arm	●
6850 mm boom	●
Arm cylinder sliding guard	○
Boom cylinder sliding guard	○

Further equipment on request

- standard equipment
- optional equipment

This specification sheet may contain attachments and optional equipment that are not available in your area. Please consult your local Komatsu distributor for those items you may require. Materials and specifications are subject to change without notice.

---

Your Komatsu partner:

**KOMATSU**

[komatsu.com](https://www.komatsu.com)

