

KOMATSU®

PC228US/LC-11

EPA Tier 4 Final Engine

Australia & New Zealand Specifications

HYDRAULIC EXCAVATOR



Photos may include optional equipment.

NET HORSEPOWER

123 kW/165 HP @ 2000 rpm

OPERATING WEIGHT

PC228US-11: 23,520 – 24,300 kg
PC228USLC-11: 23,890 – 24,670 kg

BUCKET CAPACITY

0.39 – 0.97 m³

PC228US/LC

WALK-AROUND

PC228US/LG-11



Photos may include optional equipment.

NET HORSEPOWER

123 kW/165 HP @ 2000 rpm

OPERATING WEIGHT

PC228US-11: 23,520 – 24,300 kg
PC228USLC-11: 23,890 – 24,670 kg

BUCKET CAPACITY

0.39 – 0.97 m³

FUEL ECONOMY & TIGHT TAIL PERFORMANCE

New engine and hydraulic control technology improves operational efficiency and lowers fuel consumption by up to 4%.

Rounded cab profile with a sliding door, allows the cab to swing within the same swing radius as the counterweight for true tight tail performance.

A powerful **Komatsu SAA6D107E-3** engine provides a net output of 123 kW 165 HP. This engine is EPA Tier 4 Final emissions certified.

Komatsu Variable Geometry Turbocharger (KVGIT) improves engine response and provides optimum air flow under all speed and load conditions.

Komatsu Diesel Particulate Filter (KDPF) and Selective Catalytic Reduction (SCR) system reduces particulate matter and NOx, while providing automatic regeneration that does not interfere with daily operation.

Large displacement high efficiency pumps provide high flow output at low engine speed, improving efficiency.

Enhanced working modes are designed to match engine speed, pump delivery, and system pressure to the application.

Komatsu's Closed-Centre Load Sensing System (CLSS) provides quick response and smooth operation to maximise productivity.

Temperature controlled fan clutch helps improve fuel efficiency and lower sound levels.

The **KOMTRAX®** telematics system is standard on Komatsu equipment with no subscription fees for the life of the machine. Using the latest wireless technology, **KOMTRAX®** transmits valuable information, such as location, utilisation, and maintenance records to a PC or smart-phone app. Custom machine reports are provided for identifying machine efficiency and operating trends. **KOMTRAX®** also provides advanced machine troubleshooting capabilities by continuously monitoring machine health.

Large LCD colour monitor panel:

- 7" high resolution screen
- Provides "Ecology-Guidance" for fuel efficient operation
- Enhanced attachment control

Rearview monitoring system (standard)

Equipment Management Monitoring System (EMMS) continuously monitors machine operation and vital systems to identify machine issues and assist with troubleshooting.



Enhanced working environment

- Integrated ROPS cab design (ISO 12117-2)
- Cab meets ISO Level 1 Operator Protective Guard (OPG) top guard (ISO 10262)
- Aux jack and (2) 12v outlets

Komatsu designed and manufactured components

Wide access service doors provide easy access for ground level maintenance.

Handrails (standard) provide convenient access to the upper structure.

Lockable single pole battery isolation switch allows a technician to disconnect the power supply before servicing the machine.

Komatsu Auto Idle Shutdown helps reduce nonproductive engine idle time and reduces operating costs.

Operator identification system can track machine performance for up to 100 operators.

PERFORMANCE FEATURES

KOMATSU NEW ENGINE TECHNOLOGIES

Komatsu's New Emission Regulations-compliant Engine

New regulations require the reduction of NOx emissions to one tenth or below from the proceeding regulations. Komatsu has created a regulation-compliant engine by refining the Tier 4 Interim technologies and developing a new Selective Catalytic Reduction (SCR) device in-house.

Technologies Applied to New Engine Heavy-duty aftertreatment system

This new system combines a Komatsu Diesel Particulate Filter (KDPF) and Selective Catalytic Reduction (SCR). The SCR NOx reduction system injects the correct amount of Diesel Exhaust Fluid (DEF) at the proper rate, thereby decomposing NOx into non-toxic water vapour (H₂O) and nitrogen gas (N₂).

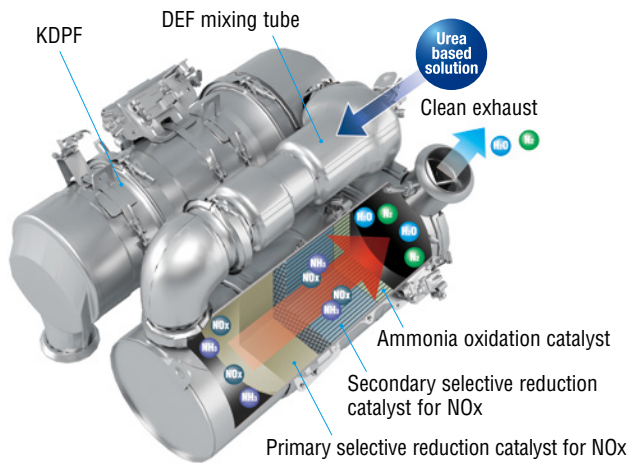

Komatsu Variable Geometry Turbocharger (KVGT) system

The VGT system features Komatsu design hydraulic technology for variable control of air-flow and supplies optimal air according to load conditions. The upgraded version realises better exhaust temperature management.

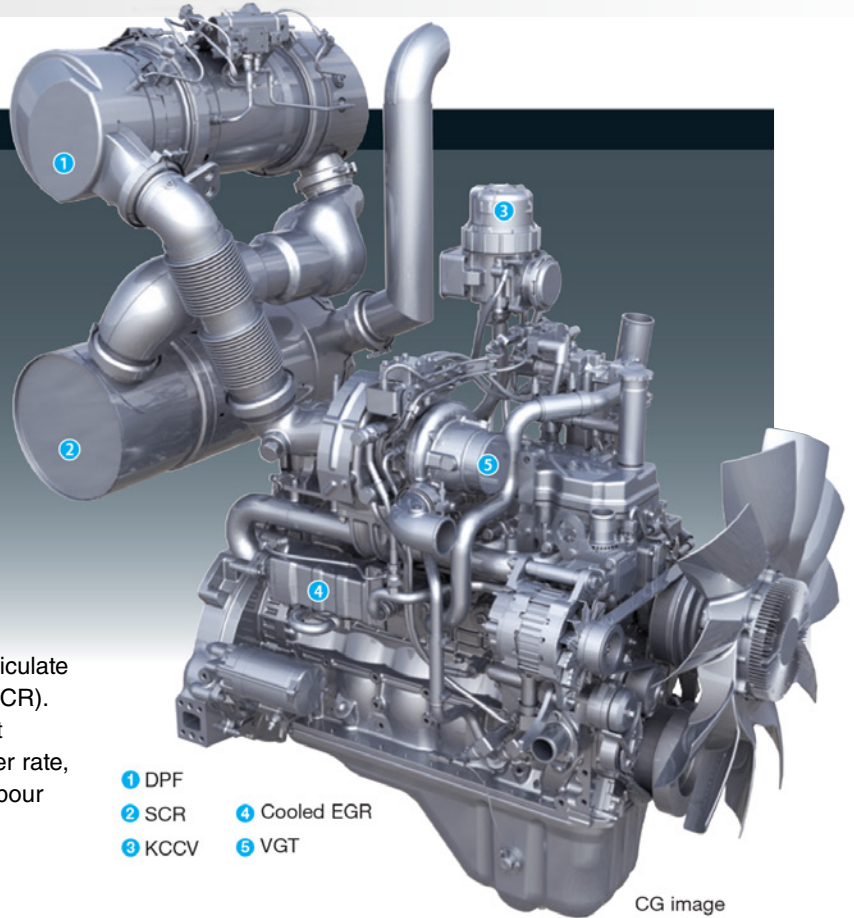
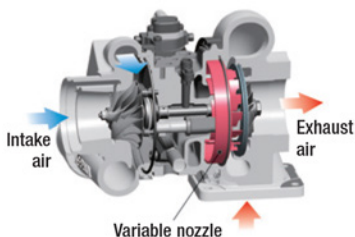

- 1 DPF
- 2 SCR
- 3 KCCV
- 4 Cooled EGR
- 5 VGT

Heavy-duty cooled Exhaust Gas Recirculation (EGR) system

The system recirculates a portion of exhaust gas into air intake and lowers combustion temperatures to reduce NOx emissions. Furthermore, while EGR gas flow is increased, by incorporating a high-efficiency and compactly designed cooling system, the system achieves a dynamic reduction of NOx, while helping reduce fuel consumption.

Advanced Electronic control system

The electronic control system performs high-speed processing of all signals from sensors installed in the machine providing total control of equipment in all operating conditions of use. Engine condition information is displayed via an onboard network to the monitor inside the cab, providing necessary information to the operator. Additionally, managing the information via KOMTRAX helps customers keep up with required maintenance.

High Pressure Common Rail (HPCR) fuel injection system

High pressure fuel injection with computerised control attains close-to-complete combustion, reducing Particulate Matter (PM) emissions. While this technology is already used in current engines, the new system uses a higher-pressure injection, thereby reducing both PM emissions and fuel consumption at all engine load conditions.

Reduced Fuel Consumption

The PC228US/LC-11's new tier 4 final engine along with enhancements in the hydraulic system considerably decreases fuel consumption.

Fuel Consumption

Reduced by 4%

(vs PC228US/LC-8 Based on typical work pattern collected via KOMTRAX)

This fuel consumption data is the result compared actual measured value using the prototype machine.

Komatsu Auto Idle Shutdown

Komatsu auto idle shutdown automatically shuts the engine down after idling for a set period of time to reduce unnecessary fuel consumption and exhaust emissions.

Viscous Fan Clutch

A temperature controlled viscous fan clutch improves engine efficiency and reduces engine power requirements when operating in cooler temperatures.

Arm Quick Return Valve

When the arm is extended, the quick return valve directs additional oil through a second line directly back to tank which reduces back pressure. Reduces fuel consumption and improves efficiency.

Increased Work Efficiency

Large Digging Force

With the one-touch Power Max function, digging force has been further increased. (8.5 seconds of operation)

Maximum arm crowd force (ISO)

101 kN(10.3t) ➔ 108 kN(11.0t) **7% UP**
(with Power Max.)

Maximum bucket digging force (ISO)

138 kN(14.1t) ➔ 149 kN(15.2t) **8% UP**
(with Power Max.)

Measured with Power Max. function, 2900 mm arm and ISO rating

Fine Controllability

Proportional Pilot Controls (PPC) allow the operator finite control and feedback with minimal effort for comfort and efficiency

Stable Platform

The PC228US/LC-11's compact 5260 kg counterweight provides exceptional lifting capacity and minimises rear swing radius for operation in confined areas.

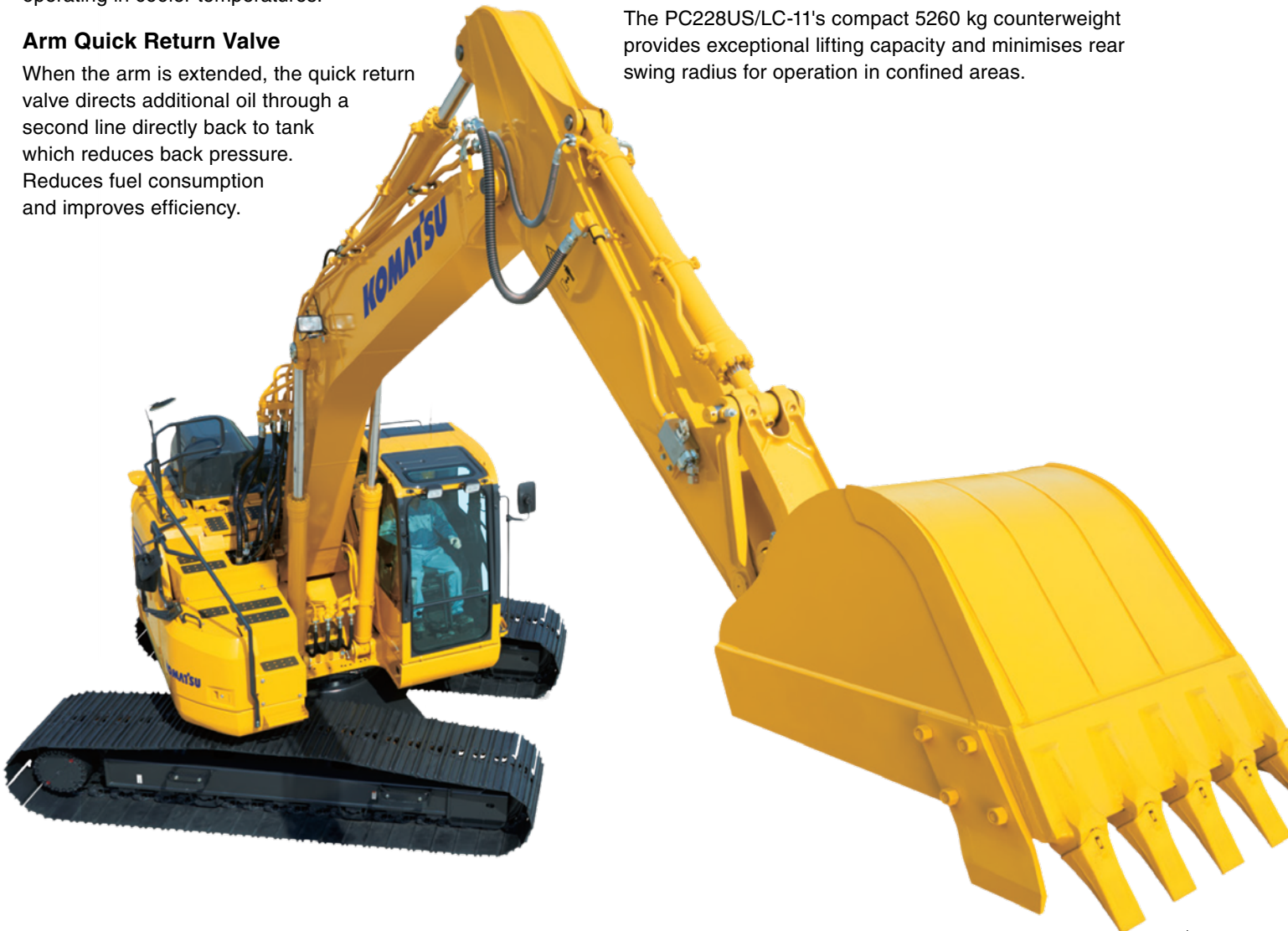

PERFORMANCE FEATURES

Efficient Hydraulic System

The PC228US/LC-11 uses a Closed-centre Load Sensing System (CLSS) that improves fuel efficiency and provides quick response to the operator's demands. The control system matches engine and hydraulic demand at the most efficient point under any load condition. There have also been improvements in the main valve and hydraulic circuit to reduce hydraulic loss, resulting in higher efficiency and lower fuel consumption.



Large Displacement High Efficiency Pump

Large displacement hydraulic implement pumps provide high flow output at lower engine RPM as well as operation at the most efficient engine speed.



Working Mode Selection

The PC228US/LC-11 excavator is equipped with six working modes (P, E, L, B, ATT/P and ATT/E). Each mode is designed to match engine speed, pump flow, and system pressure to the application. The PC228US/LC-11 features an attachment mode (ATT/E) that allows operators to run attachments while in Economy mode.

Working Mode	Application	Advantage
P	Power mode	<ul style="list-style-type: none"> •Maximum production/power •Fast cycle times
E	Economy mode	<ul style="list-style-type: none"> •Good cycle times •Better fuel economy
L	Lifting mode	<ul style="list-style-type: none"> •Increases hydraulic pressure
B	Breaker mode	<ul style="list-style-type: none"> •Optimum engine rpm, hydraulic flow
ATT/P	Attachment Power mode	<ul style="list-style-type: none"> •Optimum engine rpm, hydraulic flow, 2-way •Power mode
ATT/E	Attachment Economy mode	<ul style="list-style-type: none"> •Optimum engine rpm, hydraulic flow, 2-way •Economy mode

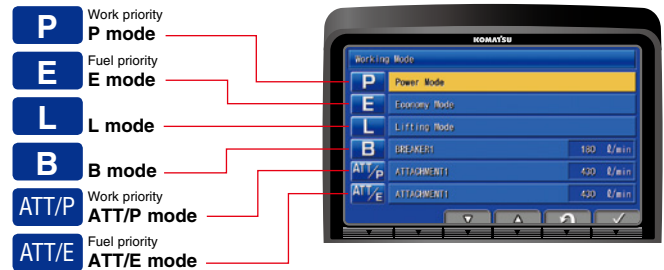

High Rigidity Work Equipment

Booms and arms are constructed with thick plates of high tensile strength steel. In addition, these structures are designed with large cross sectional areas and large one piece steel castings in the boom foot, the boom tip, and the arm tip. The result is work equipment that exhibits long term durability and high resistance to bending and torsional stress. A standard HD boom design provides increased strength and reliability.



PC228US/LC-11

OPERATIONAL FEATURES

SHORT SWING RADIUS

Ideal for Confined Applications

The PC228US/LC-11 is an ideal machine for applications such as road work, underground utilities or other applications where a conventional excavator will not fit. The contoured cab design and convex sliding door allow the cab to swing within the same radius as the counterweight. Trucks can be positioned closer to the machine when working within one lane of traffic, improving operator confidence and job efficiency.

Short Implement Swing Radius

A higher boom raise angle than a standard excavator reduces the minimum front implement swing radius down to 2310 mm. The result is greater front swing clearance when space is limited.

Short Tail Swing Radius

1785 mm short tail swing radius of the PC228US/LC-11 allows the machine to work in more confined areas than a conventional machine.



295 mm

Protrusion from the track (Rear)

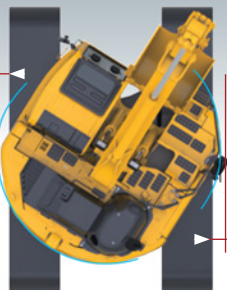

244 mm

Protrusion from the track (Step)

308 mm
(Mirror)

300 mm

Protrusion from the track (Handrail)

450 mm
(Mirror)

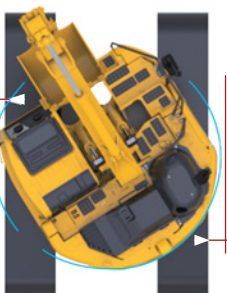

295 mm

Protrusion from the track

Greater Working Ranges

Raising the boom on the PC228US/LC-11 to a greater angle enhances overall working performance. Job sites that require a taller upper reach, such as demolition and slope cutting, also benefit from the increased digging and dumping ranges of the PC228US/LC-11.

Working range

Max. digging height

10700 mm

Max. digging depth

6620 mm

Max. digging reach

9875 mm

WORKING ENVIRONMENT

PC228US/LC-11





Comfortable Working Space

Large cab with wide front view and foot space

A large operator cab with rounded corner provides an overall cab size similar to a standard excavator cab even though this machine has an extra small swing radius. A sliding door enables easy access especially in confined work areas. Additional operator comfort is provided with a fully adjustable suspension seat.

Automatic Air Conditioner

The automatic air conditioner allows the operator to easily and precisely set the cab atmosphere using the large LCD colour monitor panel. The bi-level control function improves air flow and keeps the inside of the cab comfortable throughout the year.



Pressurised Cab

Low vibration with cab damper mounting

Low cab noise

Auxiliary input jack

Connecting an auxiliary device such as an MP3 player to the auxiliary input enables the operator to hear the sound throughout the stereo speakers installed in the cab.



Standard Equipment

AM/FM radio



Remote intermittent wiper with windshield washer

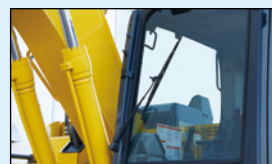

ISO Level 2 OPG



Defroster (conforms to the ISO standard)



Cup holder

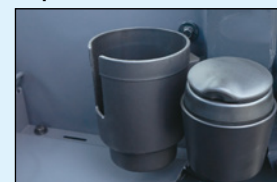

Emergency stop and level indicator

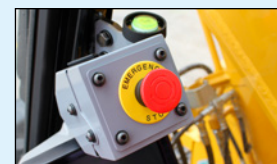

Literature box



Pull-up front window

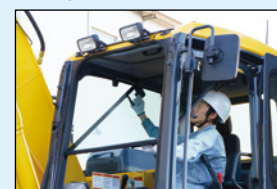

WORKING ENVIRONMENT

LARGE HIGH RESOLUTION LIQUID CRYSTAL DISPLAY (LCD) MONITOR



New Monitor Panel Interface Design

An updated, large, high-resolution LCD colour monitor enables accurate and smooth work. The redesigned interface displays key machine information in the new, user-friendly interface. A rear view camera and a DEF level gauge display now appear on the default main screen. The interface has a function that enables the main screen mode to be changed to provide the optimum screen information for the operator.

Indicators

- | | |
|------------------------------------|----------------------------|
| ① Auto-decelerator | ⑧ Fuel gauge |
| ② Working mode | ⑨ DEF level gauge |
| ③ Travel speed | ⑩ Service metre, clock |
| ④ Ecology gauge | ⑪ Fuel consumption gauge |
| ⑤ Camera display | ⑫ Guidance icon |
| ⑥ Engine coolant temperature gauge | ⑬ Function switches |
| ⑦ Hydraulic oil temperature gauge | ⑭ Camera direction display |
| | ⑮ DEF level caution lamp |

Basic operation switches

- | | |
|-------------------------|-------------------------|
| ① Auto-decelerator | ④ Buzzer cancel |
| ② Working mode selector | ⑤ Wiper |
| ③ Travel speed selector | ⑥ Window washer |
| | ⑦ Auto climate controls |

Switchable display modes

The updated monitor screen display mode can be easily switched by pressing the F3 key.



Visual user menu

Pressing the F6 key on the main screen displays the user menu screen. The menus are grouped for each function, and use easy-to-understand icons which enable the machine to be operated easily.



- | | |
|---------------------------------------|--------------------|
| ① Energy saving guidance | ② Machine settings |
| ③ Aftertreatment devices regeneration | ④ SCR information |
| ⑤ Maintenance | ⑥ Monitor setting |
| | ⑦ Message check |

Support Efficiency Improvement

Ecology guidance

While the machine is operating, ecology guidance pops up on the monitor screen to notify the operator of the status of the machine in real time.

Ecology gauge & fuel consumption gauge

The monitor screen is provided with an ecology gauge and also a fuel consumption gauge which is displayed continuously. In addition, the operator can set any desired target value of fuel consumption (within the range of the green display), enabling the machine to be operated with better fuel economy.



Ecology gauge Fuel consumption gauge
Ecology guidance

Operation record, fuel consumption history, and ecology guidance record

The ecology guidance menu enables the operator to check the operation record, fuel consumption history and ecology guidance record from the ecology guidance menu, using a single touch, thus assisting operators with reducing total fuel consumption.



Operation record

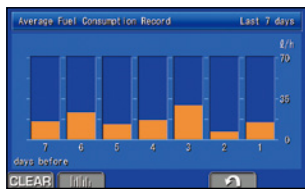

Fuel consumption history

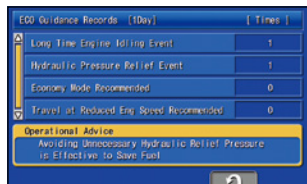

Ecology guidance record

Operator Identification Function

An operator identification ID can be set up for each operator, and used to manage operation information of individual machines using KOMTRAX data. Data sent from KOMTRAX can be used to analyse operation status by operator as well as by machine.



MAINTENANCE FEATURES

Standard high-efficiency fuel filter and fuel pre-filter with water separator

A high-efficiency fuel filter and a pre-filter with water separator increase reliability.

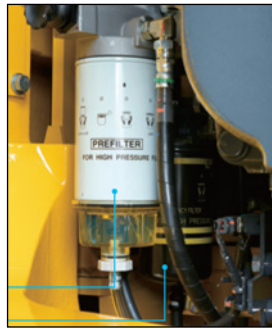

Fuel pre-filter (With water separator)
High efficiency fuel filter

Battery isolation switch

A standard battery isolation switch allows a technician to disconnect the power supply and lock out before servicing the machine.



Fan belt auto-tensioner

Side-by-side cooling

Easy access to engine oil filter, engine main fuel filter and fuel drain valve

Easy to access air conditioner filter

Easy-to-clean cab floor mat

Large tool box



Long-life oils, filters

High performance filters are used in the hydraulic circuit and engine. By increasing the oil and filter replacement intervals, maintenance costs can be significantly reduced.



Hydraulic oil filter
(Ecology-white element)

Engine oil & Engine oil filter	every 500 hours
Hydraulic oil	every 5000 hours
Hydraulic oil filter	every 1000 hours

Large capacity air cleaner

Large capacity air cleaner is comparable to that of larger machines. The larger air cleaner can extend air cleaner life during long-term operation and helps prevent early clogging, and resulting power loss. A radial seal design is used for reliability.

DEF tank

The DEF tank is installed on the right front platform for easy access. The DEF tank includes a sight glass and fold down shelf to support a DEF container during filling. A separated pump also provides excellent serviceability.



Maintenance Information

“Maintenance time caution lamp” display

When the remaining time to maintenance becomes less than 30 hours*, a maintenance time monitor appears. Pressing the F6 key switches the monitor to the maintenance screen.

* : The setting can be changed within the range between 10 and 200 hours.



Maintenance screen

Manual Stationary Regeneration

Under most conditions, active regeneration will occur automatically with no effect on machine operation. In case the operator needs to disable active regeneration or initiate a manual stationary regeneration, this can be easily accomplished through the monitor panel. A soot level indicator is displayed to show how much soot is trapped in the KDPF.

Soot level indicator



Aftertreatment device regeneration screen

Supports the DEF level and refill timing

The DEF level gauge is displayed continuously on the right side of the monitor screen. In addition, when DEF level is low, DEF low level guidance messages appear in pop up displays to inform the operator in real time.

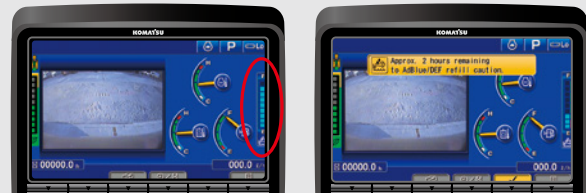

DEF level gauge

DEF low level guidance

DT-type connectors

Sealed DT-type electrical connectors provide high reliability, water and dust resistance.

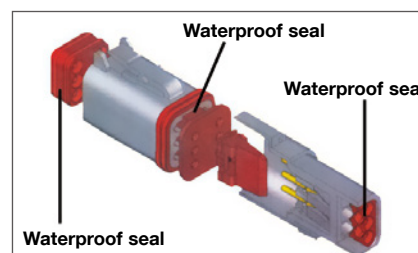

GENERAL FEATURES

KOMATSU NEW ENGINE TECHNOLOGIES

ROPS Cab (ISO 12117-2)

The machine is equipped with a ROPS cab that conforms to ISO 12117-2 for excavators as standard equipment. The ROPS cab has high shock absorption performance, featuring excellent durability and impact strength. It also satisfies the requirements for Level 1 Operator Protective Guard (OPG) and top guard (ISO 10262).



Rear View Monitoring System

An updated rear view monitoring system display has a camera image that is continuously displayed together with the gauges and important vehicle information. This enables the operator to carry out work while easily checking the surrounding area.

Rear view camera



Rear view image on monitor



Low Vibration with Viscous Cab Mounts

The PC228US/LC-11 uses viscous mounts for the cab that incorporate a longer stroke and the addition of a spring. The cab damper mounting combined with a high rigidity deck reduces vibration at the operator's seat.

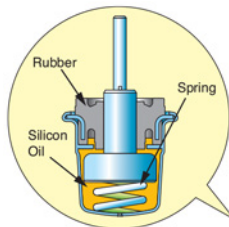

GENERAL FEATURES

- Lock lever
- Seat belt, retractable
- Tempered & tinted glass
- Large mirrors
- Slip-resistant plates
- Thermal and fan guards
- Pump/engine room partition
- Travel alarm
- Large cab entrance step
- Handrails
- Sliding door

Secondary engine shut down switch at base of seat to shutdown the engine.



KALSS AUSTRALIAN STANDARD SPECIFICATION



Rotating Amber Beacon
Fitted with factory guard.



Level Indicator, Overload Alarm & Anti-Burst Valves
Enable safety and compliance when lifting suspended loads.



Additional Lighting
Extra lighting on cab and counterweight for improved visibility.



Proportional Hand Controls
Enables proportional hand control of attachment speed.

Factory Fitted Quick Hitch and Hammer Piping

Enables use with a greater variety of attachments. Also fitted with provision for tilt circuit including valve.



Revolving Frame Under Covers
Protects and prevents ingress of material into engine bay.

Image for illustrative purposes only. US model shown.



Lower Front Window Guard
Protects cabin windscreen against rocks and debris.



Battery Isolation
Single pole, lockable Bosch-type battery isolation.



E-Stops
Allow compliance to site safety requirements.



Bolt-on Top Guard
OPG level 2 (ISO 10262) for falling object protection.

Specification also includes factory fitted provisions for fire extinguisher, turbo timer, UHF and vandal covers to reduce lead times and costs. Photos may include optional equipment.

SPECIFICATIONS



ENGINE

Model Komatsu SAA6D107E-3*
 Type Water-cooled, 4-cycle, direct injection
 Aspiration Variable geometry turbocharged,
 aftercooled, cooled EGR
 Number of cylinders 6
 Bore **107 mm** 4.21"
 Stroke **124 mm** 4.88"
 Piston displacement **6.69 ltr** 408 in3

Horsepower:
 SAE J1995 Gross **123 kW** 165 HP
 ISO 9249 / SAE J1349 Net **123 kW** 165 HP
 Rated rpm 2000

Fan drive method for cooling radiator Mechanical with
 viscous fan clutch
 Governor All-speed control, electronic

*EPA Tier 4 Final emissions certified



HYDRAULICS

Type HydraMind (Hydraulic Mechanical Intelligence)
 system, closed-centre system with load sensing valves and
 pressure compensated valves

Number of selectable working modes 6

Main pump:
 Type Variable capacity piston type
 Pumps for Boom, arm, bucket, swing, and travel circuits
 Maximum flow **490 ltr/min** 129.4 gal/min

Hydraulic motors:
 Travel 2 x piston motor with parking brake
 Swing 1 x axial piston motor with swing holding brake

Relief valve setting:
 Implement circuits **37.3 MPa 380 kgf/cm²** 5,400 psi
 Travel circuit **37.3 MPa 380 kgf/cm²** 5,400 psi
 Swing circuit **29.4 MPa 299 kgf/cm²** 4,264 psi
 Pilot circuit **3.2 MPa 33 kgf/cm²** 470 psi

Hydraulic cylinders:
 (Number of cylinders – bore x stroke x rod diameter)
 Boom **2–130 mm x 1385 mm x 90 mm** 5.11" x 54.5" x 3.5"
 Arm **1–135 mm x 1490 mm x 95 mm** 5.3" x 58.7" x 3.7"
 Bucket.. **1–115 mm x 1120 mm x 80 mm** 4.5" x 44.1" x 3.2"



DRIVES AND BRAKES

Steering control Two levers with pedals
 Drive method Fully hydrostatic
 Maximum drawbar pull **202 kN 20600 kgf** 45,410 lbf

Maximum travel speed (auto-shift):
 High **5.5 km/h** 3.4 mph
 Mid **4.1 km/h** 2.5 mph
 Low **3.0 km/h** 1.9 mph

Gradeability 70%, 35°
 Service brake Hydraulic lock
 Parking brake Mechanical disc



SWING SYSTEM

Driven by Hydraulic motor
 Swing reduction Planetary gear
 Swing circle lubrication Grease-bathed
 Service brake Hydraulic lock
 Swing lock Mechanical disc brake
 Swing speed 11.0 rpm
 Swing torque **6656 kg•m** 48,124 ft lbs



UNDERCARRIAGE

Centre frame X-frame leg
 Track frame Box-section
 Track type Sealed
 Track adjuster Hydraulic
 Number of shoes (each side) 49
 Number of carrier rollers (each side) 2
 Number of track rollers (each side) 9



COOLANT & LUBRICANT CAPACITY (REFILLING)

Fuel tank **290 ltr** 76.6 U.S gal
 Radiator **28.3 ltr** 7.6 U.S gal
 Engine **23.1 ltr** 6.1 U.S gal
 Final drive, each side **5.0 ltr** 1.4 U.S gal
 Swing drive **6.5 ltr** 1.7 U.S gal
 Hydraulic tank **126 ltr** 33.3 U.S gal
 DEF tank **13 ltr** 3.4 U.S gal



OPERATING WEIGHT (APPROXIMATE)

Operating weight includes **5700 mm** one-piece boom,
2900 mm arm, rated capacity of lubricants, coolant, full fuel
 tank, operator, standard equipment, KGA dual lock quick
 hitch, and SAE heaped **0.97 m³** bucket.

Triple- Grouser Shoes	Operating Weight		Ground Pressure	
	PC228US-11	PC228USLC-11	PC228US-11	PC228USLC-11
600 mm	23,750 kg	24,120 kg	0.53 kg/cm ²	0.51 kg/cm ²
700 mm	24,020 kg	24,390 kg	0.46 kg/cm ²	0.43 kg/cm ²
800 mm	24,300 kg	24,670 kg	0.41 kg/cm ²	0.38 kg/cm ²

Component Weights:
 Arm including bucket cylinder and linkage
2900 mm arm assembly **1057 kg** 2,331 lb
 One piece boom including arm cylinder:
5700 mm boom assembly **1788 kg** 3,942 lb
 Counterweight **5260 kg** 11,596 lb

PC228US/LG-11



DIMENSIONS

	Arm Length	2900 mm	
		PC228US-11	PC228USLC-11
A	Overall length	8830 mm	8290 mm
B	Length on ground (transport)	4960 mm	5050 mm
C	Overall height (to top of boom)*	3080 mm	3080 mm
D	Overall width	2980 mm	2980 mm
E	Overall height (to top of cab)*	3050 mm	3050 mm
F	Overall height (to top of handrail)*	3240 mm	3240 mm
G	Ground clearance, counterweight	1060 mm	1060 mm
H	Ground clearance, minimum	440 mm	440 mm
I	Tail swing radius	1785 mm	1785 mm
J	Track length on ground	3460 mm	3655 mm
K	Track length	4260 mm	4450 mm
L	Track gauge	2380 mm	2380 mm
M	Width of crawler (600 mm Shoes)	2980 mm	2980 mm
N	Grouser height	26 mm	26 mm
O	Machine upper width	2980 mm	2980 mm
P	Distance, swing centre to rear end	2130 mm	2225 mm

*Including grouser height

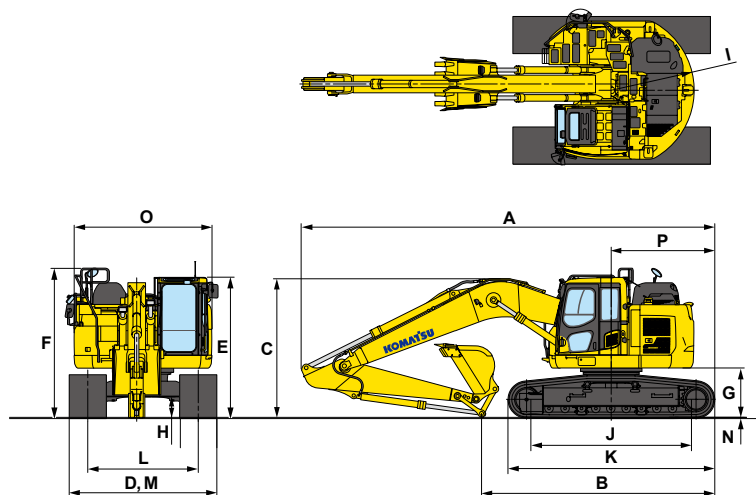

WORKING RANGE

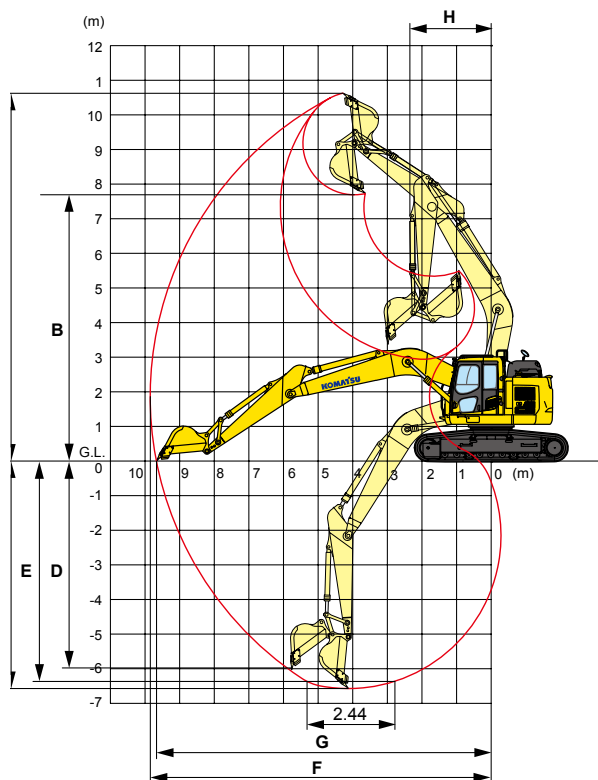

	Arm Length	2900 mm
A	Max. digging height	10700 mm
B	Max. dumping height	7825 mm
C	Max. digging depth	6620 mm
D	Max. vertical wall digging depth	5980 mm
E	Max. digging depth for 8' level bottom	6370 mm
F	Max. digging reach	9875 mm
G	Max. digging reach at ground level	9700 mm
H	Min. swing radius	2310 mm
ISO rating	Bucket digging force at power max	149 kN 15200 kgf
	Arm crowd force at power max	108 kN 11000 kgf
SAE rating	Bucket digging force at power max	132 kN 13500 kg
	Arm crowd force	103 kN 10500 kgf

LIFT CAPACITIES



LIFTING CAPACITY WITH LIFTING MODE

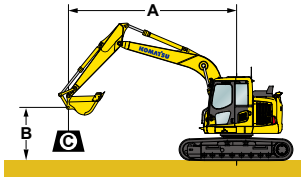

- A: Reach from swing centre
- B: Bucket hook height
- C: Lifting capacity
- Cf: Rating over front
- Cs: Rating over side
- ⊗: Rating at maximum reach

- Conditions:
- Boom length: 5700 mm
 - Arm length: 2900 mm
 - Shoes: 600 mm triple grouser
 - Bucket: 650 kg

PC228US-11

Unit: kg

B \ A	1.5 m		3.0 m		4.5 m		6.0 m		7.5 m		⊗ MAX	
	Cf	Cs	Cf	Cs	Cf	Cs	Cf	Cs	Cf	Cs	Cf	Cs
6.0 m									*3000	2800	*2650	*2650
4.5m							*5750	4200	4250	2750	*2700	2300
3.0 m			*13600	12700	*9100	6350	6100	3900	4100	2600	*2850	2000
1.5 m			*6750	*6750	9400	5750	5750	3600	3950	2450	3100	1900
0 m			*5100	*5100	8950	5350	5500	3400	3800	2300	3200	1900
-1.5 m	*5100	*5100	*9200	*9200	8750	5200	5400	3250	3750	2250	3500	2100
-3.0 m	*9650	*9650	*16200	10850	8800	5250	5400	3250			4200	2550
-4.5 m			*15800	11250	9100	5450					6050	3700

*Load is limited by hydraulic capacity rather than tipping. Ratings are based on SAE standard No. J1097. Rated loads do not exceed 87% of hydraulic lift capacity or 75% of tipping load.

PC228USLC-11

Unit: kg

B \ A	1.5 m		3.0 m		4.5 m		6.0 m		7.5 m		⊗ MAX	
	Cf	Cs	Cf	Cs	Cf	Cs	Cf	Cs	Cf	Cs	Cf	Cs
6.0 m									*3000	2850	*2650	*2650
4.5m							*5750	4250	4700	2800	*2700	2300
3.0 m			*13600	12900	*9100	6450	6750	3950	4550	2650	*2850	2050
1.5 m			*6750	*6750	10600	5850	6450	3700	4400	2500	*3150	1950
0 m			*5100	*5100	10100	5450	6200	3450	4250	2350	3550	1950
-1.5 m	*5100	*5100	*9200	*9200	9900	5300	6050	3350	4200	2300	3900	2150
-3.0 m	*9650	*9650	*16200	11050	9950	5350	6050	3350			4700	2600
-4.5 m			*15800	11450	10250	5550					6800	3800

*Load is limited by hydraulic capacity rather than tipping. Ratings are based on SAE standard No. J1097. Rated loads do not exceed 87% of hydraulic lift capacity or 75% of tipping load.

PC228US/LG-11



STANDARD EQUIPMENT

- 3 speed travel with auto shift
- Alternator 60 Ampere, 24 V
- AM/FM radio
- Arm, 2900 mm
- Auto idle
- Auto idle shutdown function
- Automatic air conditioner
- Automatic engine warm-up system
- Auxiliary input (3.5 mm jack)
- Batteries, large capacity
- Battery isolation switch, lockable
- Boom, 5700 mm
- Cab guards
 - Bolt on top guard, OPG Level 2
 - Integrated top guard, OPG Level 1
 - Bolt on top guard, OPG Level 2
- Carrier rollers, 2 each side
- Converter, 2 x 12 V
- Counterweight, 5260 kg
- Dry type air cleaner, double element
- Dual flow hammer piping
- Electric horn
- Emergency stops (3)
- Engine overheat prevention system
- Engine, Komatsu SAA6D107E-3
- EMMS monitoring system
- Fan guard structure
- Fuel pre-filter 10 micron
- High back air suspension seat with heat
- High pressure in-line hydraulic filters
- Hydraulic track adjusters
- Hydraumind closed centre load sensing system
- KOMTRAX Level 5.0
- Large LCD colour monitor, high resolution
- Level indicator
- Lock lever
- Lock lever, auto lock
- Mirrors (LH, RH & sidewise)
- Operator identification system
- Overload alarm
- Power maximising system
- PPC hydraulic control system
- Proportional control handles
- Provision for tilt circuit, including valve
- Pump/engine room partition cover
- Quick hitch piping with safety switch and alarm
- Radiator and oil cooler dustproof net
- Rear reflectors
- Rearview monitoring system (1 camera)
- Rear view monitor system
- Revolving frame undercovers
- ROPS cab (ISO 12117-2) with vandal guard provisions
- Rotating beacon with guard
- Seat belt, retractable, 78 mm
- Secondary engine shutdown switch
- Side by side coolers
- Slip-resistant foot plates
- Starting motor 5.5 kW / 24 V
- Suction fan with viscous clutch
- Thermal and fan guards
- Track frame swivel guard
- Track roller guides, 1 each side
- Track rollers, 9 each side
- Track shoe, 600 mm, triple grouser
- Travel alarm
- Working lights
 - 2 x boom
 - 3 x cab
 - 1 x counterweight
- Working mode selection system



OPTIONAL EQUIPMENT

- Autogrease system
- Battery isolation switch, dual pole, lockable
- Cab guard
 - Full front guard, OPG Level 2
- Cab vandal guard set
- Canvas seat cover
- Fire extinguisher, 1.5 kg
- Fire extinguisher, 4.5 kg
- Fire extinguisher, 9 kg
- Fuel cap vandal guard
- Jump start receptacle
- Radio, multimedia system
- Radio, UHF
- Starter circuit isolation, lockable
- Track roller guards, full length
- Track shoes, triple grouser, 700 mm
- Track shoes, triple grouser, 800 mm
- Turbo timer
- Window tinting



ATTACHMENT OPTIONS

- Bucket, general purpose, KGA 600 mm, 0.39 m³
- Bucket, general purpose, KGA 900 mm, 0.68 m³
- Bucket, general purpose, KGA 1200 mm, 0.97 m³
- Bucket, slope finishing, KGA 2000 mm, 1.10 m³
- Quick hitch, KGA, dual lock
- Quick hitch, KGA, dual lock, tilting
- Ripper, KGA, single tyne

COMING SOON

KOMATSU JMHB230V-1 Hydraulic Breaker

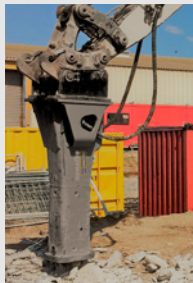

Model Type	JMHB230V-1	
Working weight	kg	1,450
Oil flow (min - max)	ℓ /min	120 - 170
Operating pressure (max)	MPa	135
Impact rate	bpm	285 - 1,050
Chisel diameter	mm	122
Acceptable back pressure	bar	8
Base machine (min - max)	Ton	18 - 30

For a complete list of available attachments, please contact your local Komatsu representative.

PC228US/LG-11

www.Komatsu.com.au

Printed in Australia

